

Body Temperature Measurement Camera User Manual



Issue	V1.0
Date	2018-12-06





Precautions

Precautions

Fully understand this document before using this device, and strictly observe rules in this document when using this device. If you install this device in public places, provide the tip "You have entered the area of electronic surveillance" in an eye-catching place. Failure to correctly use electrical products may cause fire and severe injuries. To prevent accidents, carefully read the following context:

Symbols

This document may contain the following symbols whose meanings are described accordingly.

Symbol	Description
 DANGER	It alerts you to fatal dangers which, if not avoided, may cause deaths or severe injuries.
 WARNING	It alerts you to moderate dangers which, if not avoided, may cause minor or moderate injuries.
 CAUTION	It alerts you to risks. Neglect of these risks may cause device damage, data loss, device performance deterioration, or unpredictable results.
 TIP	It provides a tip that may help you resolve problems or save time.
 NOTE	It provides additional information.



DANGER

To prevent electric shocks or other dangers, keep power plugs dry and clean.



WARNING

- Strictly observe installation requirements when installing the device. The manufacturer shall not be held responsible for device damage caused by users' non-conformance to these requirements.

- Strictly conform to local electrical safety standards and use power adapters which are marked with the LPS standard when installing and using this device. Otherwise, this device may be damaged.
- Use accessories delivered with this device. The voltage must meet input voltage requirements for this device.
- If this device is installed in places with unsteady voltage, ground the device to discharge high energy such as electrical surges in order to prevent the power supply from burning out.
- When this device is in use, ensure that no water or any liquid flows into the device. If water or liquid unexpectedly flows into the device, immediately power off the device and disconnect all cables (such as power cables and network cables) from this device.
- Do not place the thermal imaging camera and unpackaged products at a radiation source with a high intensity regardless of whether the device is in the normal power-on state, for example, the sun, laser, and electric arc welder, and place the thermal imaging camera and unpackaged products against objects with a high heat source, for example, the sun. Otherwise, the accuracy of the thermal imaging camera will be affected. In addition, the detector in the thermal imaging camera may be permanently damaged.
- If this device is installed in places where thunder and lightning frequently occur, ground the device nearby to discharge high energy such as thunder strikes in order to prevent device damage.

**CAUTION**

- Unless otherwise specified in the user manual, do not use the thermal imaging camera in an environment with the temperature lower than -10°C (+14F) or higher than 50°C (+122F). Otherwise, the images displayed by the thermal imaging camera are abnormal and the device may be damaged if working beyond the temperature range for a long period.
- During the outdoor installation, prevent the morning or evening sunlight incidence to the lens of the thermal imaging camera. The sun shade must be installed and adjusted according to the angle of the sunlight illumination.
- Avoid heavy loads, intensive shakes, and soaking to prevent damages during transportation and storage. The warranty does not cover any device damage that is caused during secondary packaging and transportation after the original packaging is taken apart.
- This device is a static sensitivity device. Improper static may damage the thermal imaging camera. ESD protection measures and reliable grounding must be well prepared for device installation and uninstallation.
- Protect this device from fall-down and intensive strikes, keep the device away from magnetic field interference, and do not install the device in places with shaking surfaces or under shocks.
- Use a soft and dry cloth to clean the device body. In case that the dirt is hard to remove, use a dry cloth dipped in a small amount of mild detergent and gently wipe

the device, and then dry it again. Pay special attention to the front window of the thermal imaging camera because this is precision optics. If the front window has water spots, use a clean and soft cloth moistened with water to wipe it. If the front window needs further cleaning, use a soft cloth dampened with isopropyl alcohol or detergent. Improper cleaning can cause damage to the device.

- The lens window of the thermal imaging camera is designed to be applicable to an outdoor environment. The window is coated with durable coating material, but may require frequent cleaning. When you found lens image degradation or excessive accumulation of pollutants, you should clear up the window in a timely manner. Exercise caution when you use this device in severe sandstorm (such as deserts) or corrosive environments (such as offshore). Improper use may cause surface coating off.
- Do not jam the ventilation opening. Follow the installation instructions provided in this document when installing the device.
- Keep the device away from heat sources such as radiators, electric heaters, or other heat equipment.
- Keep the device away from moist, dusty, extremely hot or cold places, or places with strong electric radiation.
- If the device is installed outdoors, take insect- and moisture-proof measures to avoid circuit board corrosion that can affect monitoring.
- Remove the power plug if the device is idle for a long time.
- Before unpacking, check whether the fragile sticker is damaged. If the fragile sticker is damaged, contact customer services or sales personnel. The manufacturer shall not be held responsible for any artificial damage of the fragile sticker.

Special Announcement

All complete products sold by the manufacturer are delivered along with nameplates, operation instructions, and accessories after strict inspection. The manufacturer shall not be held responsible for counterfeit products.

This manual may contain misprints, technology information that is not accurate enough, or product function and operation description that is slightly inconsistent with the actual product. The manufacturer will update this manual according to product function enhancement or changes and regularly update the software and hardware described in this manual. Update information will be added to new versions of this manual without prior notice.

This manual is only for reference and does not ensure that the information is totally consistent with the actual product. For consistency, see the actual product.

Contents

Precautions	ii
Contents	v
1 Product Overview	1
1.1 About Product.....	1
1.2 Cable Connection	5
1.3 Features	1
2 Device Dimensions	3
3 Quick Configuration	7
3.1 Login and Logout	7
3.2 Homepage Layout	8
3.3 Changing the Password	10
3.4 Browsing Video.....	11
3.4.1 Install Plugins.....	13
3.5 Setting Local Network Parameters	14
4 Visible Sensor Configuration	18
4.1 Accessing the Sensor Interface	18
4.2 Time Segment.....	18
4.3 Image Adjust	19
4.4 Scene	21
4.5 Exposure.....	22
4.6 WB	23
4.7 DayNight.....	24
4.8 Noise Reduction	26
4.9 Enhance Image	27
4.10 Zoom Focus.....	28
5 Thermal Sensor Configuration	30
5.1 Accessing the Sensor Interface	30
5.2 Time Segment.....	30
5.3 Images	31
5.4 Scene	32
5.5 Set Pseudocolor.....	33

5.6 FFC Control	35
5.7 Noise Reduction	36
5.8 Enhance Image	37
6 Human Thermometer Setting.....	39
6.1 Parameter Configure.....	39
6.1.1 Schedule Linkage	43
6.2 Thermal Mapping	44
6.3 Bad Point Check.....	46
6.4 Thermal Calibration	47
7 Intelligent Analysis	48
7.1 Perimeter	48
7.2 Single Virtual Fence	51
7.3 Double Virtual Fences	55
7.4 Loiter.....	59
7.5 Multiple Loiter	62
7.6 Object Left	65
7.7 Object Removed.....	67
7.8 Abnormal Speed	70
7.9 Converse.....	73
7.10 Illegal Parking	76
7.11 Signal Bad	79
8 Alarm Setting.....	81
8.1 Alarm Output.....	81
8.2 Disk Alarm	81
8.3 Network Alarm.....	82
8.4 I/O Alarm Linkage	83
8.5 Motion Alarm	84
8.6 Push Message	85
9 Other Web Configurations.....	87
9.1 Device Information	87
9.2 Stream	87
9.2.1 Base Stream.....	87
9.2.2 SVC Stream.....	88
9.2.3 ROI.....	89
9.3 Device	90
9.4 External Device	90

9.5 Device Record	92
9.6 Privacy Masking.....	92
9.7 Network Service.....	93
9.8 Privacy Manager	93
9.9 Protocol	94
9.10 Device Log	94
9.11 Maintenance	96
9.12 Local Config.....	96
10 Technical Specifications	97

1 Product Overview

1.1 About Product

- The body temperature measurement camera is integrated with the thermal imaging and temperature measuring, visible fusion, core image intelligent analysis, etc.
- Unique double registration mechanism, visible light and thermal imaging is reflecting the same scene.
- The body temperature measurement camera is high precision , that is less than 0.3 °C and built-in automatic temperature correction, completely eliminate the temperature drift, it can work stable and reliable for long time.
- Real-time temperature measure, synchronous automatically measure, response time within 30 milliseconds when test people through the detection area, make sure there are no omissions.
- Intelligent body temperature and visible light image channel display details information to easily monitor and discriminate.
- Smart over temperature alarm and location, sound and light alarm, track rapidly when temperature was abnormal.

It is suitable for customs, schools, airports, stations, prisons and other public places with large flow of people to conduct rapid temperature screening.

1.2 Features

- Using the uncooled infrared focal plane sensor.
- Detecting the infrared wavelength ranging from 8 um to 14 um.
- 400*300 pixels.
- High thermal sensitivity, reaching 50mK.
- Supporting dedicated lens for 8/15/25/35/50 mm focal distance (optional).
- Supporting 17 pseudo color modes such as black hot, white hot, rainbow, iron bow and so on.
- Supporting the DVE image enhancement.
- Supporting noise reduction and mirroring.
- Supporting three coding algorithms, there are H.265, H.264 and MJPEG, it is high compatibility.

- In the heat setting temperature measuring points in the image or temperature area, temperature detection and display: point temperature measurement, regional temperature measuring, full screen, temperature measurement.
- Over-temperature warning and over-temperature alarm.
- Outputting three code streams in real time, and satisfying local storage and network transmission of the video.
- 1-channel audio input and 1-channel audio output, supporting bidirectional voice talkback.
- Supporting the local storage of the Micro SD card (the maximum capacity is 128 GB) and effectively resolving the video loss problem caused by network failure.
- Supporting NAS storage.
- Providing software and hardware watchdogs and automatic fault recovery.
- Linked heat dissipation structure of the metal enclosure.
- DC 12 V /2A/POE.

1.3 Device Dimensions

1.4 shows the dimensions of device.

Figure 1-1 Dimensions (unit: mm)

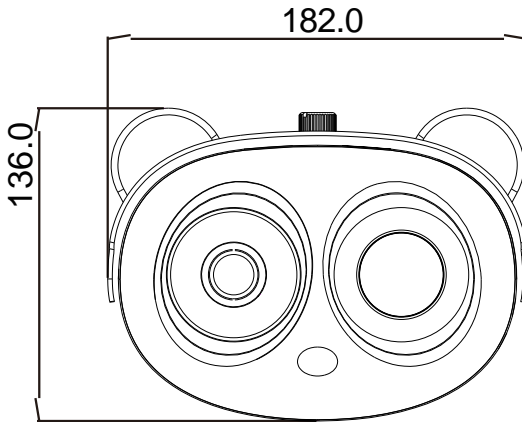
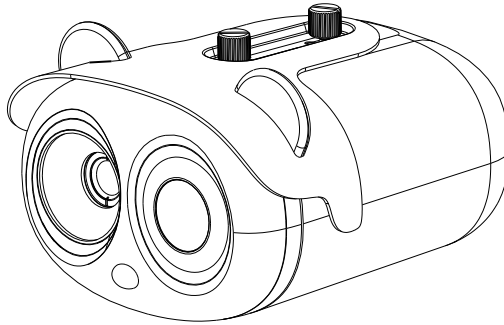

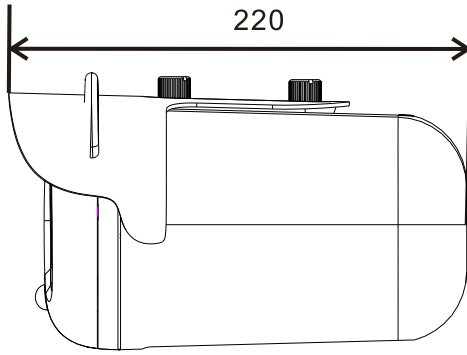

1.4 Cable Connection

Figure 1-2 the multi-connector combination cable of the thermal imaging integrated network camera. For details about the multi-connector combination cable, please refer to Table 1-1.

Figure 1-2 Multi-connector combination cable

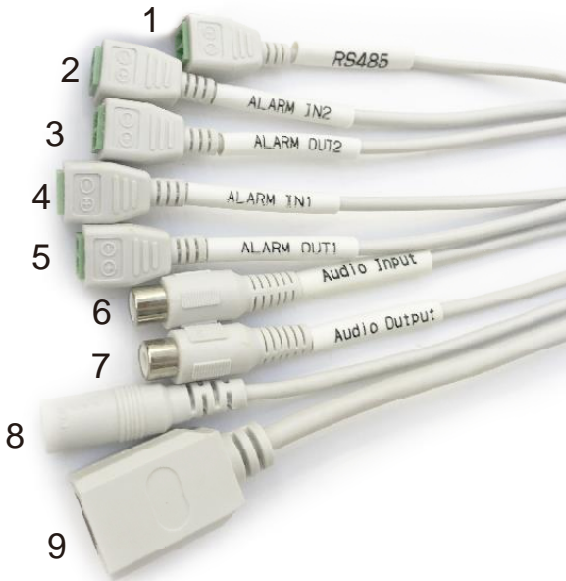

Table 1-1 Multi-connector combination cable

ID	Core of Cable	Functions
1	RS485	RS485 interface connects to the external pan & tilt.
2	ALARM IN2	Connects to the alarm device.
3	ALARM OUT2	
4	ALARM IN1	
5	ALARM OUT1	
6	Audio Input	Inputs the audio signal and receives the analog

		audio signals from the sound pick-up device.
7	Audio Output	Connects to the external audio device such as the voice box.
8	DC12V (2A)	Power interface, connects to the 12 V DC power supply or AC24V.
9	Network interface	Connects to the standard Ethernet cable.

2 Quick Configuration

2.1 Login and Logout



CAUTION

You must use Internet Explorer 7 or a later version to access the web management system; otherwise, some functions may be unavailable.

Login system

- Step 1 Open the Internet Explorer, enter the IP address of camera (default value is 192.168.0.121) in the address box, and press Enter.

The login page is displayed, as shown in Figure 2-1.

Figure 2-1 Login page

The screenshot shows the login interface for an IP camera. It features a light blue header with the text 'IP CAMERA' in a large, bold, blue font. To the right of the header, there is a language selection dropdown menu currently set to 'English'. Below the header, there are two input fields: 'User Name' and 'Password'. To the right of these fields is a blue 'Login' button.

- Step 2 Input the user name and password.

**NOTE**

- The default name and password both are **admin**. Modify the password when you log in the system for first time to ensure system security. After modifying password, you need to wait at least three minutes then power off to make sure modifying successfully . Or login the Web again to check the new password.
- User can change the system display language on the login page.

Step 3 Click Login. The homepage is displayed.

----End

logout

To logout of system, click  in the upper right corner of the homepage, the login page is displayed after you logout of the system.

2.2 Homepage Layout

On the homepage, user can view real-time video, playback and configuration. User can set parameter, Video parameter, Video control, PTZ control, PTZ Configure and logout of the system. Figure 2-2 is shown the homepage layout. Table 2-1 lists the elements on the homepage layout.

Figure 2-2 Homepage layout

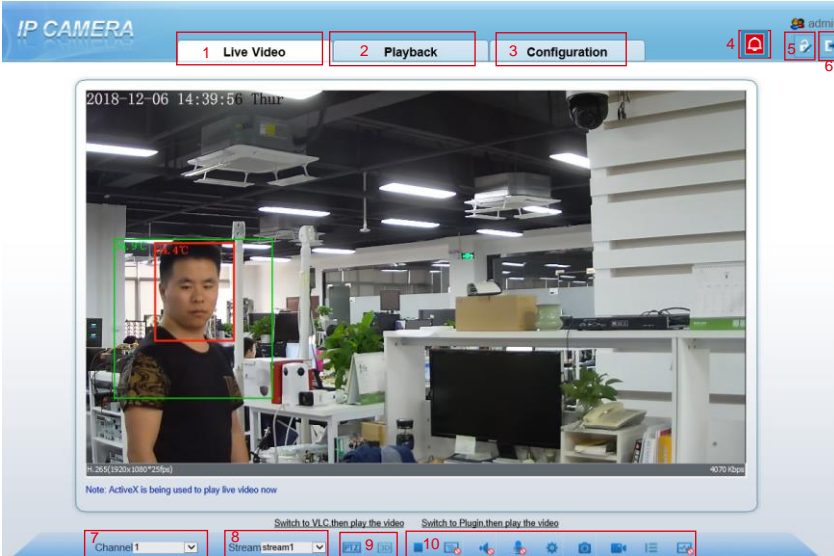



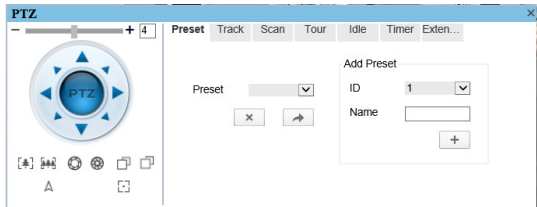









Table 2-1 Elements on the homepage

NO.	Element	Description
1	Real-time video area	Real-time videos are played in this area. You can also set sensor parameters.
2	Playback	You can query the playback videos in this area. NOTE Only when the SD card or NAS have videos that you can query the playback videos.
3	Configuration	You can choose a menu to set device parameters, including the device information, audio and video streams, alarm setting, and privacy mask function.
4	Alarm icon	When the device generates an alarm, the alarm icon  is displayed. You can click  to view the alarm information. NOTE When the device accepts an alarm signal, the alarm icon will display within 10s in the web management system.
5	Change password	You can click  to change the password.
6	Sign Out	You can click  to return to the login page.

NO.	Element	Description
7	Channel	Channel 1: visible light. Channel 2: thermal image.
8	Stream	Three modes. You can set details at configuration base stream interface.
9	PTZ	
10		 :play/pause  :switch the mode  :audio  :interphone  :sensor, or click right mouse button, more details please refer to <i>chapter 3</i> .  :snapshot  :record video to local storage  :intelligent analysis, more details please refer to <i>chapter 5</i>

----End

2.3 Changing the Password

Description

User can click  to change the password for logging in to the system.

Procedure

Step 1 Click  in the upper right corner of the main page.

The **Change Password** dialog box is displayed, as shown in Figure 2-3.

Figure 2-3 Change password dialog box

Change Password x

Old Password

New Password

Confirm

Password Advice:

1. Advice the password length of eight characters.
2. Advice the password includes numbers, capital letters, lowercase letters and special characters.
3. Advice the password can not be the same as username.

NOTE

- The change password page will be displayed if you don't change the default password when you login the system for the first time.

Step 2 Input the old password, new password, and confirm password.

Step 3 Click **OK**.

If the message "**Change own password success**" is displayed, the password is successfully changed. If the password fails to be changed, the cause is displayed. (For example, the new password length couldn't be less than eight.)

----End

2.4 Browse Video

User can browse the real-time video in the web management system.

Preparation

To ensure the real-time video can be played properly, you must perform the following operations when you log in to the web for the first time:

Step 1 Open the Internet Explorer. Choose **Tools > Internet options > Security > Trusted**

sites > Sites.

In the display dialog box, click **Add**, as shown in Figure 2-4.

Figure 2-4 Adding the a trusted site

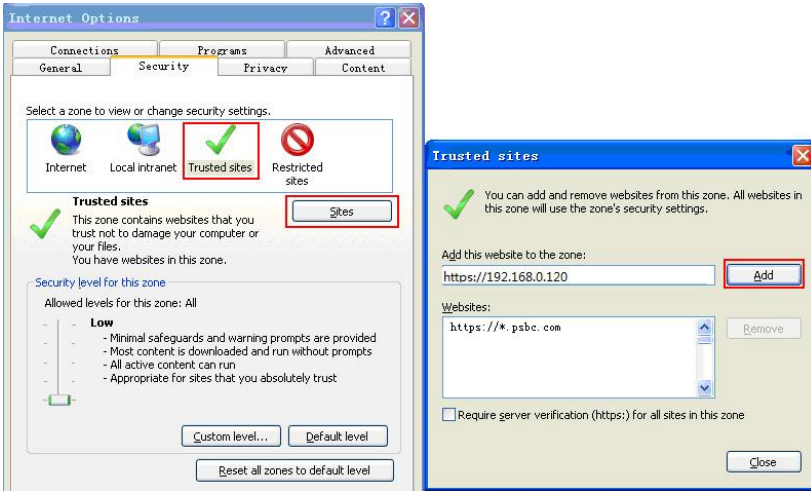

Step 2 In the Internet Explorer, choose **Tool > Internet Options > Security > Customer level**, and set **Download unsigned ActiveX control and initialize and script ActiveX controls not marked as safe for scripting under ActiveX controls and plug-ins to Enable**, as shown in Figure 2-5.

Figure 2-5 Configuring ActiveX control and plug-ins

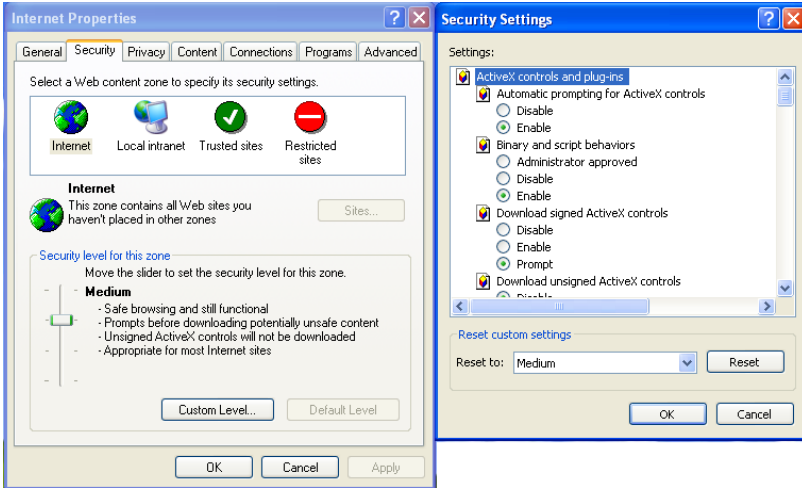

Step 3 Download and install the player control as prompted.

NOTE

- The login page is displayed when the control is loaded.

2.4.1 Install Plugins

You will be prompted with a message “[click here to use short delay Plugin for Live Video](#)” as shown in Figure 2-6 when you log in to the web management system for the first time.

Figure 2-6 Download the plugin page

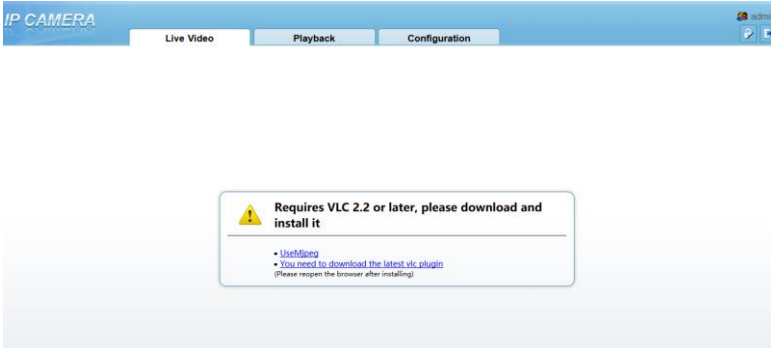

Procedure

- Step 1 Click the message, download and install the plugin follow the prompts.
- Step 2 Reopen the browser after installation.
- Step 3 On live video page, you can operate these buttons as shown in live video.



NOTE

- Channel switch, choose channel 1 view the visible picture, channel 2 is thermal picture.
- During installing plugins, you need to close the browser, finish the installation, login the device again.

----End

2.5 Setting Local Network Parameters

Description

Local network parameters include:

- IP protocol
- IP address
- Subnet mask
- Default gateway
- Dynamic Host Configuration Protocol (DHCP)
- Preferred Domain Name System (DNS) server
- Alternate DNS server
- MTU

Procedure

- Step 1 Choose **Configuration > Device >Local Network**.

The **Local Network** page is displayed, as shown in Figure 2-7.

Figure 2-7 Device information

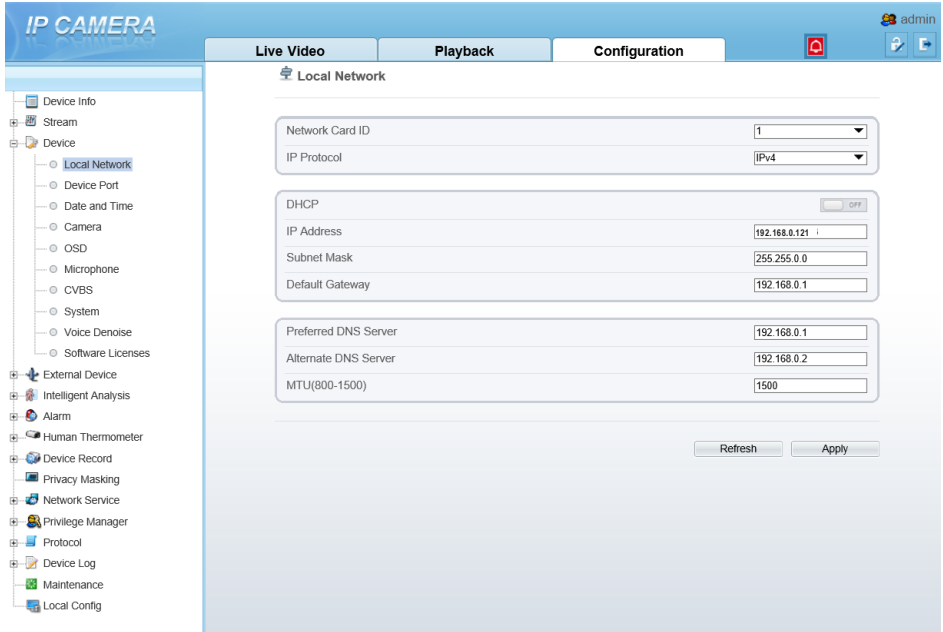

Step 2 Set the parameters according to Table 2-2.

Table 2-2 Local network parameters

Parameter	Description	Setting
IP Protocol	IPv4 is the IP protocol that uses an address length of 32 bits.	[Setting method] Select a value from the drop-down list box. [Default value] IPv4
DHCP	The device automatically obtains the IP address from the DHCP server.	[Setting method] Click the option button. NOTE To query the current IP address of the device, you must query it on the platform based on the device name.
DHCP IP	IP address that the DHCP server assigned to the device.	N/A

Parameter	Description	Setting
IP Address	Device IP address that can be set as required.	[Setting method] Enter a value manually. [Default value] 192.168.0.121
Subnet Mask	Subnet mask of the network adapter.	[Setting method] Enter a value manually. [Default value] 255.255.255.0
Default Gateway	This parameter must be set if the client accesses the device through a gateway.	[Setting method] Enter a value manually. [Default value] 192.168.0.1
Preferred DNS Server	IP address of a DNS server.	[Setting method] Enter a value manually. [Default value] 192.168.0.1
Alternate DNS Server	IP address of a domain server. If the preferred DNS server is faulty, the device uses the alternate DNS server to resolve domain names.	[Setting method] Enter a value manually. [Default value] 192.168.0.2
MTU	Set the maximum value of network transmission data packets.	[Setting method] Enter a value manually. NOTE The MTU value is range from 800 to 1500, the default value is 1500, Please do not change it arbitrarily.

Step 3 Click **OK**.

- If the message "**Apply success**" is displayed, click OK. The system saves the settings. The message "**Set network param's success, Please login system again**" is displayed. Use the new IP address to log in to the web management system.
- If the message "Invalid IP Address", "**Invalid Subnet Mask**", "**Invalid default gateway**", "**Invalid primary DNS**", or "**Invalid space DNS**" is displayed, set the parameters correctly.

**NOTE**

- If you set only the Subnet Mask, Default Gateway, Preferred DNS Server, and Alternate DNS Server parameters, you do not need to login to the system again.
- You can click Reset to restore the previous parameters if required.

----End

3 Visible Sensor Configuration

3.1 Accessing the Sensor Interface

Procedure

Step 1 On the web or NVMS interface, move the cursor to the real-time video page and right-click on the page. A shortcut menu is displayed, as shown in Figure 3-1

Figure 3-1 Sensor setting interface

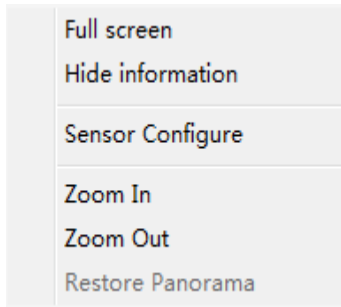

Step 2 Choose **Sensor Configure** and the **Sensor Setting** dialog box appears.

NOTE

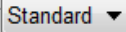
- All sensor configure can be modified at debug mode. Click  in the lower left corner of Sensor Setting, and choose **Debug Mode**.

3.2 Time Segment

Step 1 Click  in the lower left corner of Sensor Setting, and choose **Debug Mode**. As shown in Figure 3-2.

Figure 3-2 Time segment



Step 2 Tick **Enable**.

Step 3 Set the Start Time

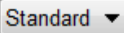
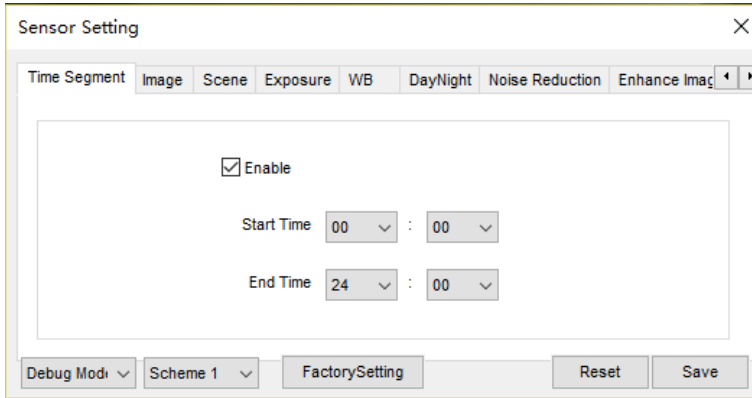
Step 4 Set the End Time

Step 5 Click **Save**, the message "Save success" is displayed, the system saves the settings.

3.3 Image Adjust

Figure 3-3 shows the Image Adjust tab page.

Figure 3-3 Image

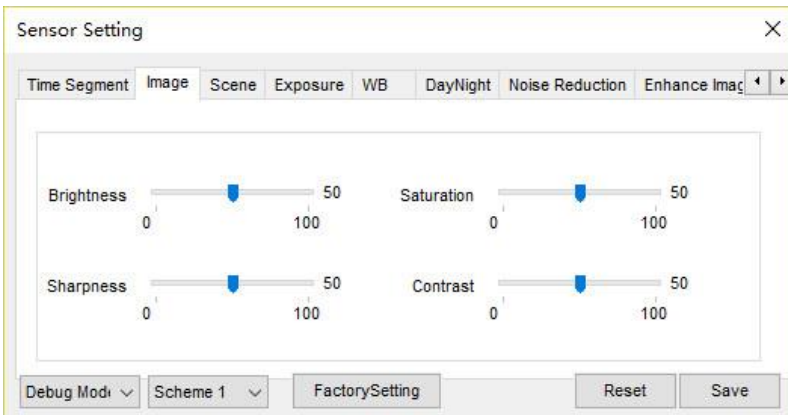

Table 3-1 describes the parameters on the Image Adjust tab page.

Table 3-1 Parameters of Image

Parameter	Description	Configuration Method
Brightness	It indicates the total brightness of an image. As the value increases, the image becomes brighter.	[Setting method] Drag the slider. [Default value] 50
Sharpness	It indicates the border sharpness of an image. As the value increases, the borders become clearer, and the number of noise points increases.	[Setting method] Drag the slider. [Default value] 50
Saturation	It indicates the color saturation of an image. As the value increases, the image becomes more colorful.	[Setting method] Drag the slider. [Default value] 50
Contrast	It indicates the measurement of different brightness levels between the brightest white and darkest black in an image. The larger the difference range is, the greater the contrast; the smaller the difference range is, the smaller the contrast	[Setting method] Drag the slider. [Default value] 50

3.4 Scene

Figure 3-4 shows the scene tab page.

Figure 3-4 Scene

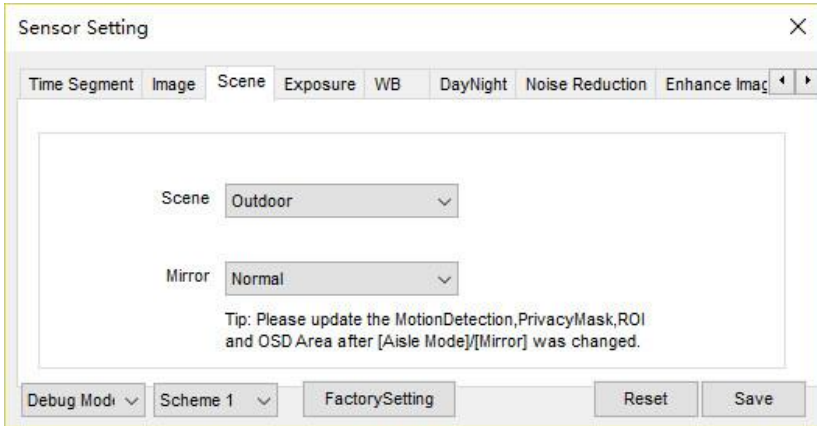

Table 3-2 describes the parameters on the scene tab page.

Table 3-2 Parameters of scene

Parameter	Description	Configuration Method
Scene	Indoor or outdoor.	[Setting method] Select a value from the drop-down list. [Default value] Indoor
Mirror	It is used to select the pixel location of an image. <ul style="list-style-type: none"> • Normal: The image does not flip. • Horizontal: The image flips to the left and right. • Vertical: The image flips up and down. • Horizontal+ Vertical: The image rotates at 180 degrees. 	[Setting method] Select a value from the drop-down list. [Default value] Normal

3.5 Exposure

Figure 3-5 shows the Exposure tab page.

Figure 3-5 Exposure

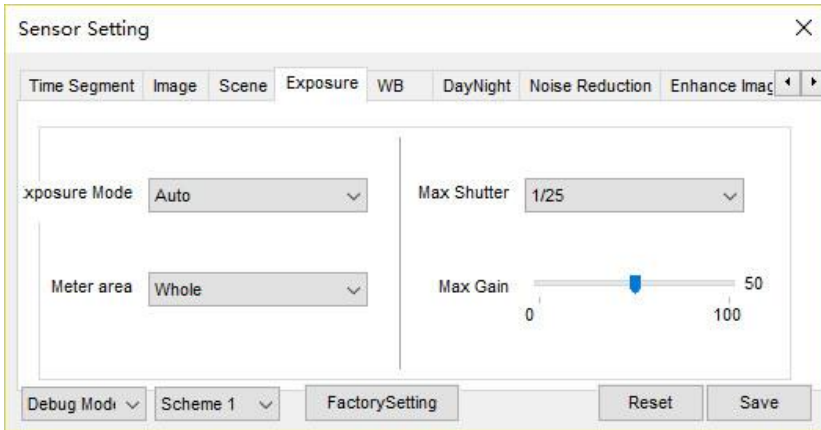

Table 3-3 describes the parameters on the Exposure setting tab page.

Table 3-3 Parameters of exposure setting

Parameter	Description	Configuration Method
Exposure Mode	<p>The exposure modes include:</p> <ul style="list-style-type: none"> • Auto: The system performs auto exposure based on the monitoring environment. • Shutter Priority: You can set Shutter Setting to fixed values. The iris and gain are automatically adjusted by the system. • Iris Priority: You can set Iris Setting to fixed values. The shutter and gain are automatically adjusted by the system. 	<p>[Setting method] Select a value from the drop-down list. [Default value] Auto</p>
Meter area	Choose the area to meter	<p>[Setting method] Select a value from the drop-down list. [Default value] Whole</p>

Max Shutter	It is valid in Iris Priority mode. You can select a maximum shutter speed. As the value increases, the image becomes brighter.	[Setting method] Select a value from the drop-down list. [Default value] 1/25
Max gain	It indicates the maximum gain. The device automatically adjusts the gain based on the external light, and the gain is less than or equal to the value of this parameter.	[Setting method] Drag the slider. [Default value] 50

3.6 WB

Figure 3-6 shows the WB tab page.

Figure 3-6 WB

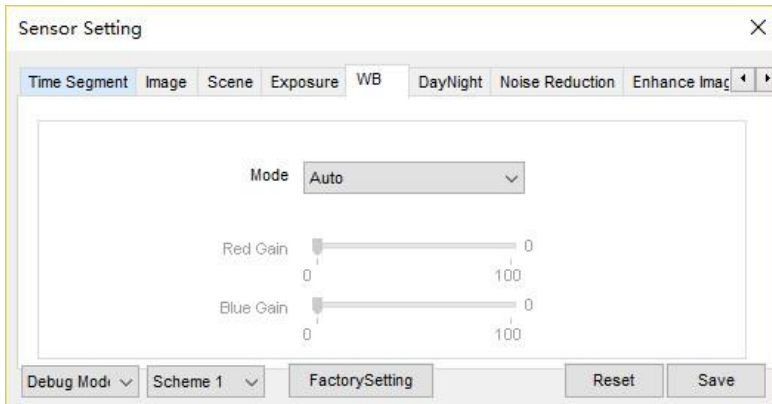

Table 3-4 describes the parameters on the WB tab page.

Table 3-4 Parameters of WB

Parameter	Description	Configuration Method
Mode	<p>It is used to display the real color of a monitoring scenario when the color temperature changes.</p> <ul style="list-style-type: none"> • Auto: camera adjusts automatically. • Tungsten: at tungsten lamp environment. • Fluorescent: fluorescent environment. • Daylight: at daylight environment. • Shadow: at low light environment. • Manual: adjust red and blue gain manually. 	<p>[Setting method] Select a value from the drop-down list. [Default value] Auto</p>

3.7 DayNight

Figure 3-7 shows the day-night tab page.

Figure 3-7 Day-night

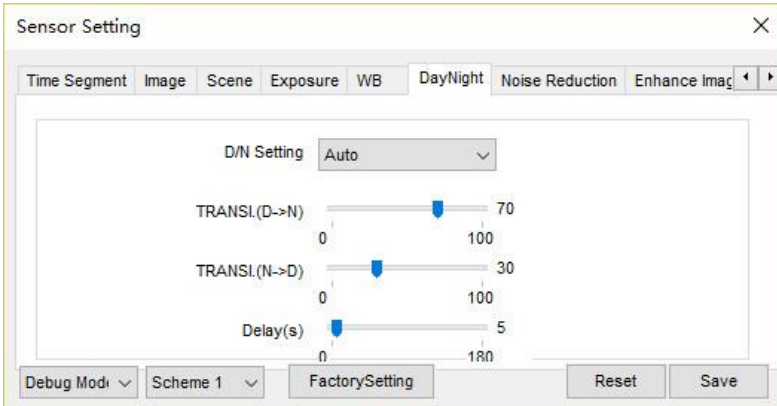

Table 3-5 describes the parameters on the Special Function tab page.

Table 3-5 Parameters of day night

Parameter	Description	Configuration Method
DayNight Mode	<p>It can be set to Auto, Day Mode, Night Mode and Timing.</p> <ul style="list-style-type: none"> • Auto mode The image color is adjusted based on the day/night mode. In auto mode, the image switches between the colored state and the black and white state based on the brightness. In day mode, the image is colored. In night mode, the image is black and white. • Day mode The image is colored, and the filter is in the day state, preventing infrared light from entering the sensor. • Night mode The image is black and white, and the filter is in the night state, allowing all types of light to enter the sensor. • Timing Select time from the drop-down list by the “Day To Night Time” and “Night To Day Time”. 	<p>[Setting method] Select a value from the drop-down list. [Default value] Day Mode</p>
Trans (D to N)	Day transit to night.	<p>[Setting method] Drag the slider. [Default value] 50</p>
Trans (N to D)	Night transit to day.	<p>[Setting method] Drag the slider. [Default value] 50</p>
Delay	N/A	<p>[Setting method] Drag the slider. [Default value] 5</p>

3.8 Noise Reduction

Figure 3-8 shows the noise reduction tab page.

Figure 3-8 Noise Reduction

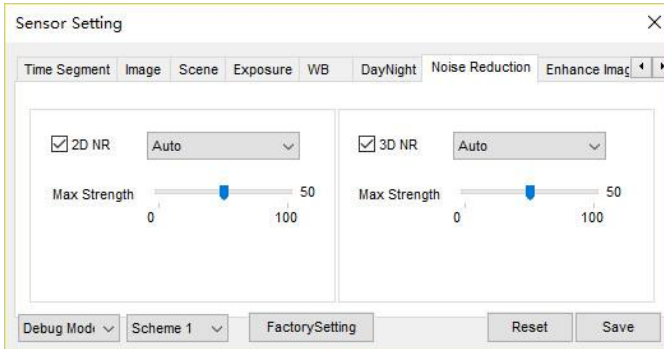

Table 3-6 describes the parameters on the Special Function tab page.

Table 3-6 Parameters of noise reduction

Parameter	Description	Configuration Method
2D NR	Auto /manual, default value is auto. By comparing and screening the images of the two frames before and after, the noise point position is found out and gain control is carried out on them.	[Setting method] Drag the slider strength. [Default value] 50
3D NR	Auto /manual, default value is auto. The 3D digital noise reduction function can reduce the noise interference of the weak signal image.	[Setting method] Drag the slider of strength. [Default value] 50

3.9 Enhance Image

Figure 3-9 shows the enhance image Setting tab page.

Figure 3-9 Enhance image

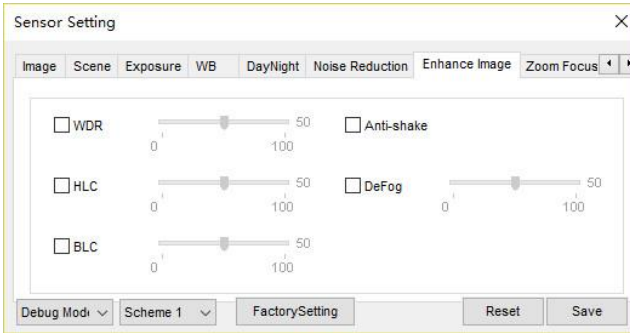



Table 3-7 describes the parameters on the enhance image setting tab page.

Table 3-7 Parameters of enhance image

Parameter	Description	Configuration Method
WDR	It is intended to provide clear image performance in strong backlight areas such as exterior light coming through a window or glass door. High contract light conditions are no longer a problem when you need to capture detailed images.	[Setting method] Drag the slider. [Default value] 50
HLC	It indicates reverse bright points in the picture to black. As an effective approach to recognize vehicle plate number at night, HLC function can detect any spotlight diffused by object-vehicle and compensate it for obtaining clearer image.	[Setting method] Drag the slider. [Default value] 50
BLC	It indicates Back Light Compensation (BLC) automatically brings more detail to darker areas of an image when bright light shining from behind obscures it and provides perfect exposure for an object in front of very strong back light. The electronic shutter of the camera basically adjusts its exposure to try to allow for more light to be allowed in the darker areas.  NOTE This parameter applies only to visible light.	[Setting method] Drag the slider. [Default value] 50

Anti-shake		[Default value] Disable
Defog	It indicates the camera defog automatically.	[Setting method] Drag the slider. [Default value] 50

3.10 Zoom Focus

Figure 3-10 shows the enhance image Setting tab page.

Figure 3-10 Zoom focus

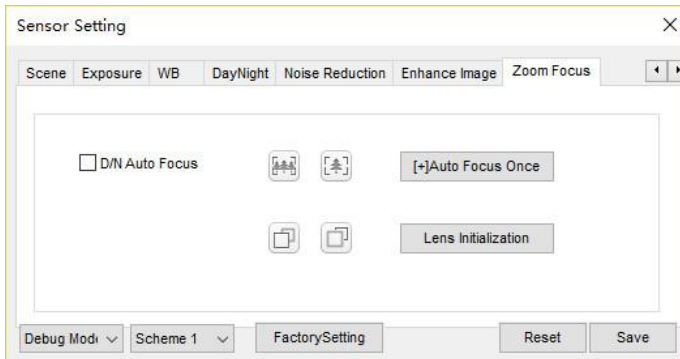





Table 3-8 describes the parameters on the enhance image setting tab page.

Table 3-8 Parameters of zoom focus

Parameter	Description	Configuration Method
D/N Auto Focus	Enable the function, if the light is changed, it will focus automatically.	[Setting method] Tick

	 :zoom out  :zoom in  :near focus  :far focus	[Setting method] Click
Auto focus once	N/A	[Setting method] Click
Lens initialization	N/A	[Setting method] Click

4 Thermal Sensor Configuration

4.1 Accessing the Sensor Interface

Operation Procedure

- Step 1 On the Internet Explorer interface or the client software interface, select and right-click the surveillance image to the set, as shown in Figure 4-1.

Figure 4-1 Sensor configuration

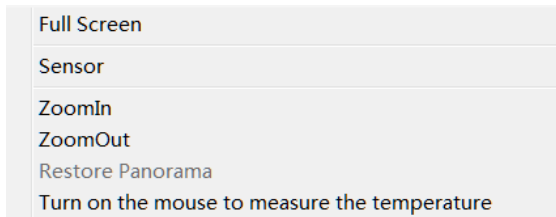

- Step 2 Choose **Sensor**. The **Sensor Configuration** dialog box is displayed, as shown in Figure 4-2.

----End

4.2 Time Segment

Figure 4-2 shows the time segment interface.

Figure 4-2 Time segment interface

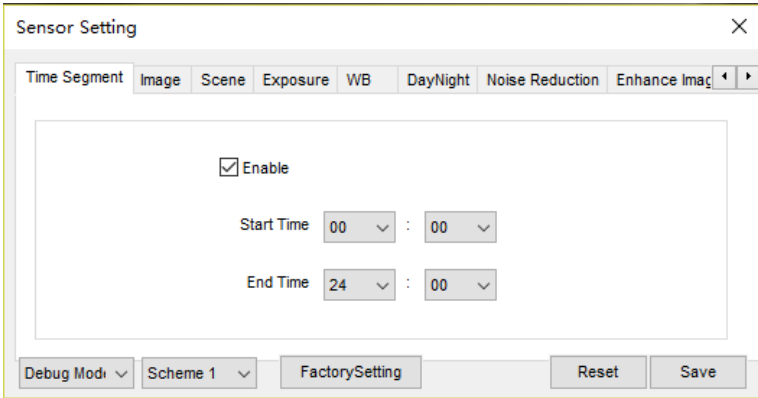

Operation Procedure

- Step 2 Click **Standard** in the lower left corner of Sensor Setting, and choose **Debug Mode**.
- Step 3 Tick **Enable**.
- Step 4 Set the Start Time.
- Step 5 Set the End Time.
- Step 6 Click **Save**, the message "Save success" is displayed, the system saves the settings.

----End

4.3 Images

Figure 4-3 shows the image setting interface.

Figure 4-3 Image setting interface

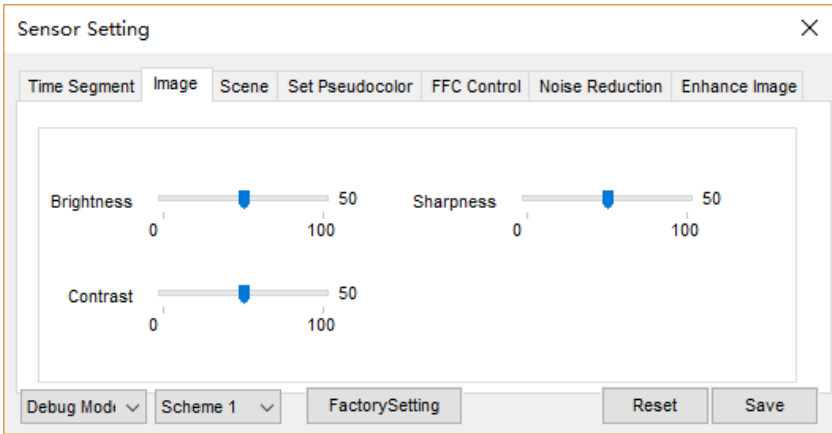

Step 2 Click **Standard** in the lower left corner of Sensor Setting, and choose **Debug Mode**.

Step 3 Drag the slider to adjust parameter of image.

Step 4 Click **Save**, the message "Save success" is displayed, the system saves the settings.

NOTE

- **Brightness:** It indicates the total brightness of an image. As the value increases, the image becomes brighter. It ranges from 0 to 100.
- **Contrast:** It indicates the contrast between the bright part and the dark part of an image. As the value increases, the contrast increases. It ranges from 0 to 100.
- **Sharpness:** it indicates the contrast between definition and edge sharpness. The higher value, the higher definition and greater distortion. It ranges from 0 to 100

----End

4.4 Scene

Figure 4-4 shows the scene setting interface.

Figure 4-4 Scene setting interface

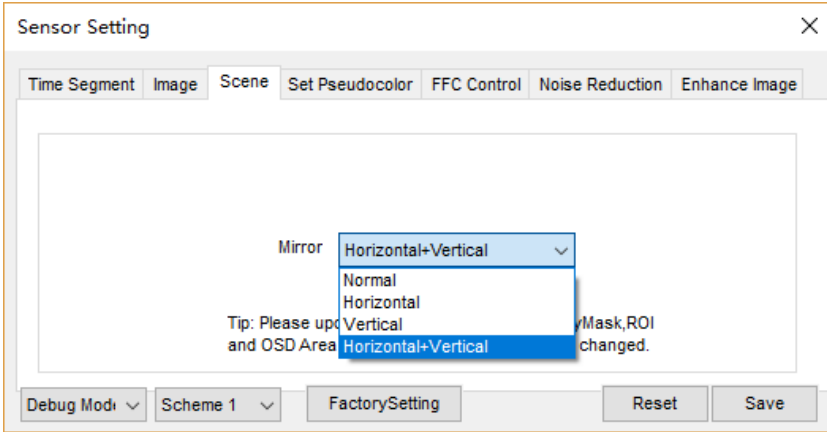

- Step 2 Click **Standard** in the lower left corner of Sensor Setting, and choose **scene**
- Step 3 Choose mirror mode from drop-list.
- Step 4 Click **Save**, the message "Save success" is displayed, the system saves the settings.

 **NOTE**

- Mirror providing the selection of image pixel locations.
- Normal: the image is not flipped.
- Horizontal: the image is flipped left and right.
- Vertical: the image is flipped up and down.
- Picture Flip: the image is rotated at 180 degree.

----End

4.5 Set Pseudocolor

Figure 4-5 shows the scene setting interface.

Figure 4-5 Set pseudocolor setting interface

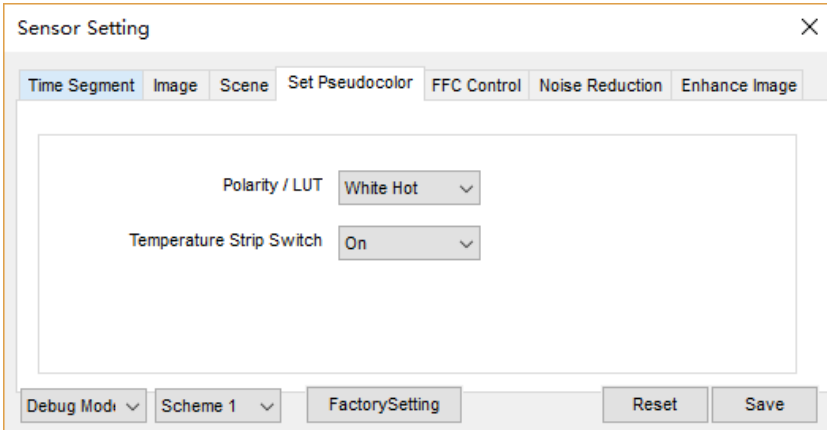

- Step 2 Click **Standard** in the lower left corner of Sensor Setting, and choose **set pseudo color**
- Step 3 Choose polarity/LUT mode from drop-list.
- Step 4 Enable or disable the temperature strip switch
- Step 5 Click **Save**, the message "Save success" is displayed, the system saves the settings.

NOTE

- The temperatures of the temperature fields detected by the thermal imaging camera are separately mapped to values ranging from 0 to 255 by the algorithm. In the black/white display mode, this range is converted to the gray scale tones. For example, 0 indicates completely black, and 255 indicates completely white. The temperature field of the scene is converted to images by using the grayscale ranging from 0 to 255. Different polarity modes can be converted to different display images. The most common setting is white hot (a hotter object is displayed brighter than a colder object) or black hot (a hotter object is displayed darker than a colder object). The difference between two modes lies in that the temperatures corresponding to the darker one and the lighter one are reversed. Other modes include rainbow, ironbow, HSV, autumn, bone and so on.

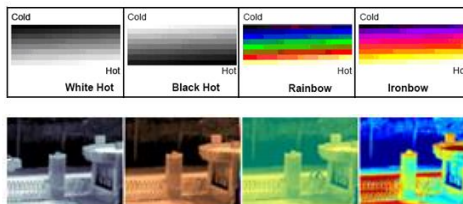

4.6 FFC Control

Figure 4-6 shows the FFC control interface.

Figure 4-6 FFC control interface

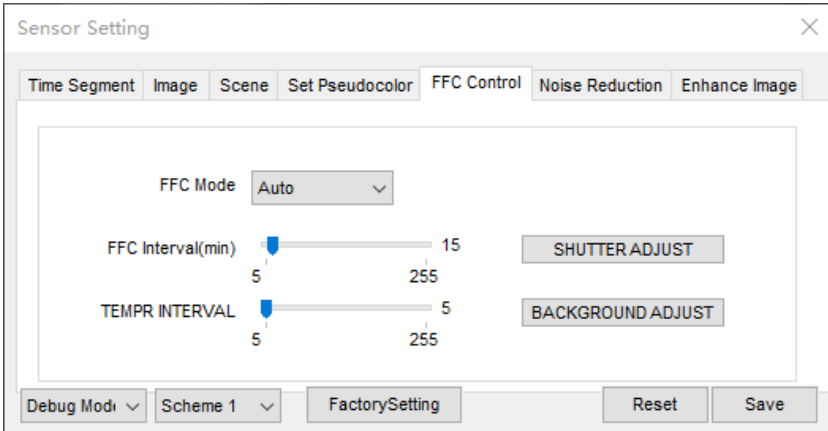

Table 4-1 lists the parameters on the FFC control interface.

Table 4-1 Parameters on the FFC control interface

Parameter	Description	Setting
FFC Mode	<p>The internal of the thermal imaging camera may comprise the mechanical action correction mechanism that can periodically improve the image quality. This component is called flat field correction (FFC). When controlling the FFC, the FFC shields the sensor array, so that each portion of the sensor can collect uniform temperature fields (flat field). By means of FFC, the camera can update the correction coefficients to output more uniform images. Throughout the FFC process, the video image is frozen for two seconds and a static-frame image is displayed. After the FFC is complete, the image is automatically recovered. Repeated FFC operations can prevent the grainy and image degradation problems. The FFC is especially important when the temperature of the camera changes. For example, after the camera is powered on or the ambient temperature is changed, you should immediately perform the FFC.</p> <p>Auto: In the Automatic FFC mode, the camera performs FFC whenever its temperature changes by a specified amount or at the end of a specified</p>	<p>[How to set] Select from the drop-down list box. [Default value] Auto</p>

Parameter	Description	Setting
	<p>period of time (whichever comes first). When this mode is selected, the FFC interval (minutes) ranges from 5 to 30 minutes. The temperature change of the camera is based on the temperatures collected by the internal temperature probe. The temperature of the camera sharply changes when the camera is powered on. The FFC is relatively frequent, which is normal.</p> <p>Manual: In the manual FFC mode, the camera does not automatically perform the FFC based on the temperature change or the specified period. You can press the Do FFC button to select the manual FFC mode. When you feel that the image is obviously degraded but the automatic FFC is not performed, you can use the manual FFC function to check whether the image quality can be improved.</p>	
FFC interval (min)	In the automatic FFC mode, the FFC interval ranges from 5 to 255 minutes. When the time reach to setting value, the camera do shutter adjust operation automatically.	<p>[How to set] Select by dragging the slider. [Default value] 5</p>
Tempr interval	In the automatic FFC mode, the tempr interval value ranges from 5 to 255 degree centigrade. When the time reach to setting value, the camera do background adjust operation automatically.	<p>[How to set] Select by dragging the slider. [Default value] 5</p>
Shutter adjust	Click the icon and camera perform the action.	Manually
Background adjust	Click the icon and camera perform the action.	Manually

----End

4.7 Noise Reduction

Figure 4-7 shows the Noise reduction interface.

Figure 4-7 Noise reduction interface

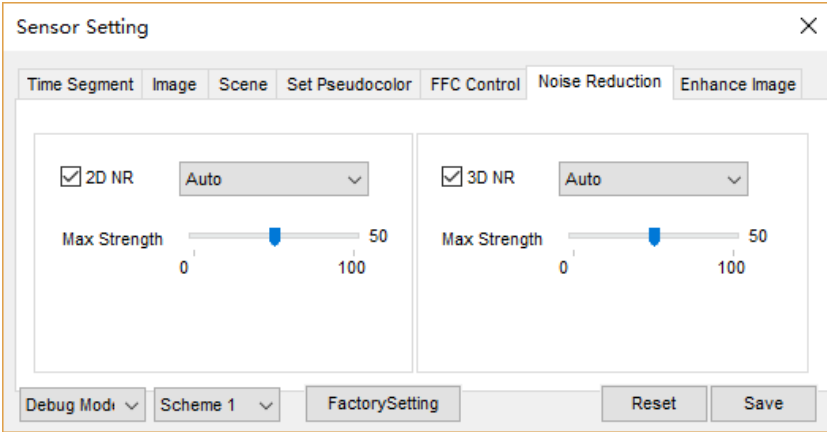

Table 4-2 lists the Noise reduction parameters.

Table 4-2 Parameters on the Noise reduction interface

Parameter	Description	Setting
2DNR	Decrease the image noise.	[How to set] Select from the drop-down list box. [Default value] Close
3DNR	Decrease the image noise.	[How to set] Select from the drop-down list box. [Default value] Close

----End

4.8 Enhance Image

Figure 4-8 shows the **Enhance image** interface.

Figure 4-8 Enhance image interface

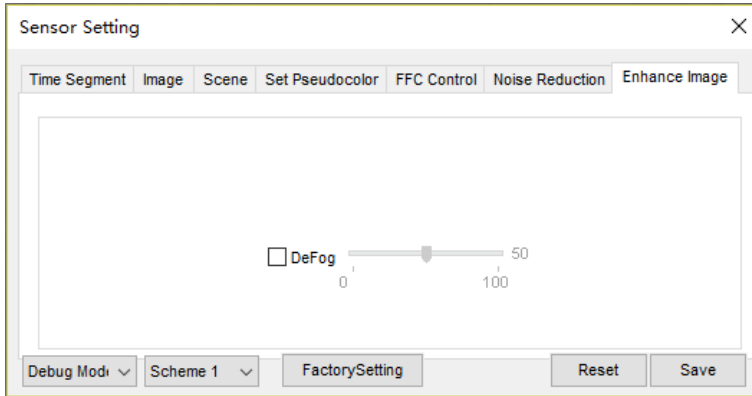

Step 2 Click **Standard** in the lower left corner of Sensor Setting, and choose **enhance image**.

Step 3 Tick **defog**, then drag the slider to set. It ranges from 0-100, the default value is 50.

Step 4 Click **Save**, the message "**Save success**" is displayed, the system saves the settings.

----End

5 Human Thermometer Setting

5.1 Parameter Configure

Operation Procedure

Step 1 Choose Configuration > human thermometer > parameter configure.

The **parameter configure** page is displayed, as shown in Figure 5-1.

Figure 5-1 Temperature Parameters interface

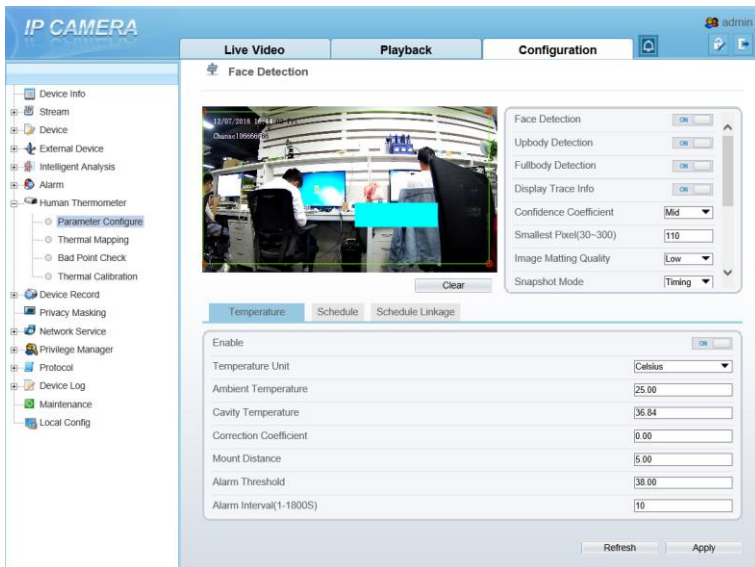

Step 2 Set the parameters according to Table 5-1.

Table 5-1 Parameter of face detection

Parameter	Description	Setting
Face detection	Detect face of human	[Setting method]

		Enable the button [Default value] On
Upbody detection	Detect face and shoulder part of human	[Setting method] Enable the button [Default value] Off
Fullbody detection	Detect the human shape	[Setting method] Enable the button [Default value] Off
Display trace	Display the information of tracing	[Setting method] Enable the button [Default value] On
Confidence coefficient	Face detection sensitivity, the value range is high, medium, low, the larger the value is, the higher the sensitivity. The higher the sensitivity value is, the higher the detection rate will be, but the more false detection may occur, such as the false detection of the patterns on pedestrian clothes to adult faces.	[Setting method] Choose from drop -list [Default value] Medium
Smallest pixel	When the pixel of the face in the image is less than the set value (the minimum pixel for face recognition), it is not captured.	[Setting method] Input a number from 30 to 300 [Default value] 60
Snapshot mode	There are two types timing and optimal.	[Setting method] Choose from drop -list [Default value] Timing
Upload image interval	N/A	[Setting method] Input a number from 1 to 10 [Default value] 5
Yaw degree	Set face Angle to filter out	[Setting method]

	Angle is too large face, it maybe not detect the face.	Input a number from 0 to 90 [Default value] 30
Tilt degree	N/A	[Setting method] Input a number from 0 to 90 [Default value] 30
FTP upload image matting	Enable or disable.	[Default value] Disable
FTP upload whole image	Enable or disable.	[Default value] Disable

Table 5-2 Temperature parameters

Parameter	Description	Setting
Temperature Unit	Celsius and Fahrenheit temperature units are available.	[Setting method] Select a value from the drop-down list box. [Default value] Celsius
Ambient Type	The ambient of camera. Outside and Inside are available. Inside suggest to be selected when the ambient temperature change frequently.	[Setting method] Select a value from the drop-down list box. [Default value] Outside
Ambient Temperature	The ambient temperature of camera. It is set when ambient is outside.	[Setting method] Enter a value manually.
Cavity Temperature	The cavity temperature of camera.	N/A

Parameter	Description	Setting
Correction Coefficient	Correction coefficient refers to the deviation of measured object temperature and actual temperature. For example: 1.The measured object temperature is 30, and actual temperature is 37, so the correction coefficient is 7 . 2. The measured object temperature is 37, and actual temperature is 30, so the correction coefficient is -7 .	[Setting method] Enter a value manually. [Default value] 0.00
Area Temperature Display Mode	The display position of temperature information on the live-video image.	[Setting method] Input the value [Default value] 5
Mount distance	The actual distance between the detection person and the device, it is set to facilitate the temperature measurement accuracy.	[Setting method] Select a value from the drop-down list box. [Default value] General
Alarm Threshold	The human body temperature detected exceeds the set threshold temperature alarm.	[Setting method] Enter a value manually. [Default value] 38
Alarm Interval(1-1800S)	N/A	[Setting method] Input a number from 1 to 1800 [Default value] 10
Measure Mode	Choose the measure mode from general to preset.	[Setting method] Select a value from the drop-down list box. [Default value] General
Display alarm area	Enable or disable the display alarm area	N/A

Parameter	Description	Setting
Area alarm interval	Set the area alarm interval from 1 to1800s	[Setting method] Enter a value manually.

----End

5.1.1 Schedule Linkage

Operation Procedure

Step 1 Choose Configuration >human thermometer >parameter configure> Schedule Linkage.

The **Schedule Linkage** page is displayed, as shown in Figure 5-2.

Figure 5-2 Schedule Linkage

Schedule Linkage

Threshold Alarm | Threshold Warning | Temperature Difference Alarm | Temperature Difference Warning

Output Channel 1 2

Alarm Record

SMTP

FTP Upload

0 1 2 3 4 5 6 7 8 9 10 11 12 13 14 15 16 17 18 19 20 21 22 23 24

Sun

Mon

Tues

Wed

Thur

Fri

Sat

Step 2 Choose threshold alarm, threshold temperature difference alarm, threshold warming and temperature difference warming to set. All of these four settings are the same ways to set.



Step 3 Check the output channel.

Step 4 Set schedule linkage.

Step 5 Click **Apply**.

Step 6 The message "**Apply success**" is displayed, the system saves the settings.

 **NOTE**

- **Method 1:** Click left mouse button to select any time point within 0:00-24:00 from Monday to Sunday as shown in Figure 5-2.
- **Method 2:** Hold down the left mouse button, drag and release mouse to select the alarm time within 0:00-24:00 from Monday to Sunday.
- When you select time by dragging the cursor, the cursor cannot be moved out of the time area. Otherwise, no time can be selected.
- **Method 3:** Click  in the alarm time page to select the whole day or whole week.
- **Deleting alarm time:** Click  again or inverse selection to delete the selected alarm time.

----End

5.2 Thermal Mapping

Operation Procedure

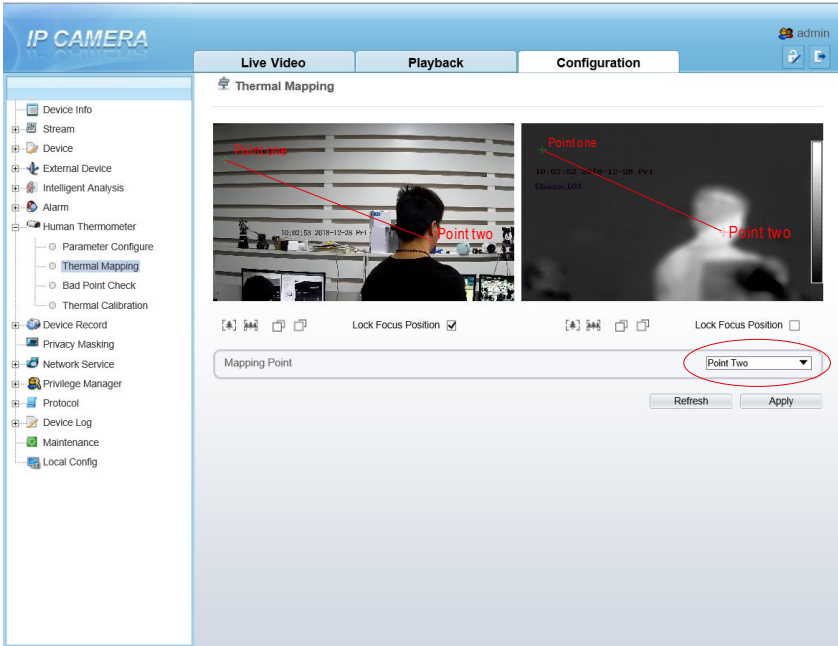

Step 1 Choose **Configuration >human thermometer >thermal mapping**, as shown in Figure 5-3.

Figure 5-3 Thermal mapping interface



Step 2 Settings please refer to Table 5-3.

Table 5-3 Parameter of thermal mapping

Parameter	Description	Setting
	Zoom in /zoom out.	[Setting method] Click the button
	Near focus / far focus.	[Setting method] Click the button
Lock focus position	N/A	[Setting method] Tick .
Mapping point	You need map two point at two channels. Points are correspond of each.	[Setting method] Select from drop list .

Step 3 Click **Apply**. The message "**Apply success**" is displayed, the system saves the settings.

----End

5.3 Bad Point Check

NOTE

- This function only can be used after the device manufacturer's confirmation.

Operation Procedure

Step 1 Choose **Configuration >human thermometer >bad point check**, as shown in Figure 5-4.

Figure 5-4 Bad point check interface

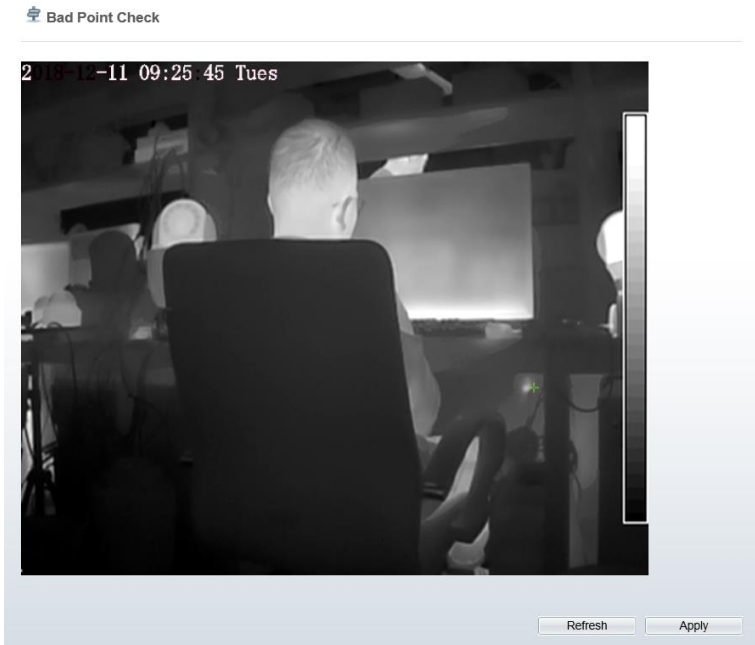

Step 2 There are granular white points on the image, click the left mouse button, the click **apply** to repair the bad point.

----End

5.4 Thermal Calibration

Enable the thermal calibration function; you need the special calibration tool to check the temperature, input the target temperature (the special calibration tool's temperature), emission rate and distance of tool, the software can compute automatically.

Operation Procedure

Step 1 Choose **Configuration >human thermometer >thermal mapping**, as shown in Figure 5-5.

Figure 5-5 Thermal calibration interface

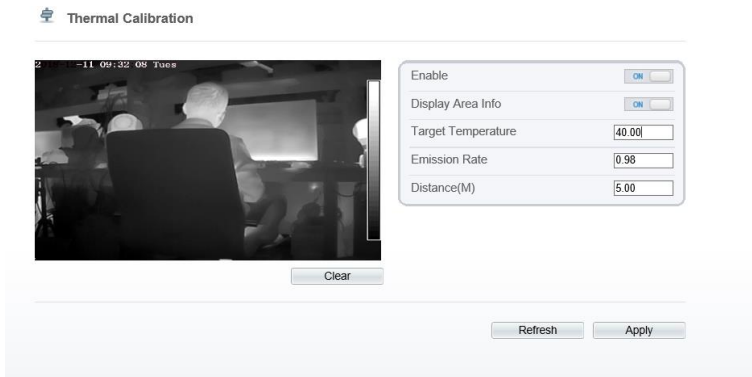

Step 2 Enable the button and display area info.

Step 3 Input the target temperature, emission rate and distance.

Step 4 Click **Apply**. The message "**Apply success**" is displayed, the system saves the settings.

NOTE

- Emission please refers to B Common Emission Rate.
- Distance depends the actual installation distance.

6 Intelligent Analysis

6.1 Perimeter

Description

The perimeter function refers to that an alarm is generated when the targets of specified types (such as person, car, and both person and car) enter the deployment area.

Procedure

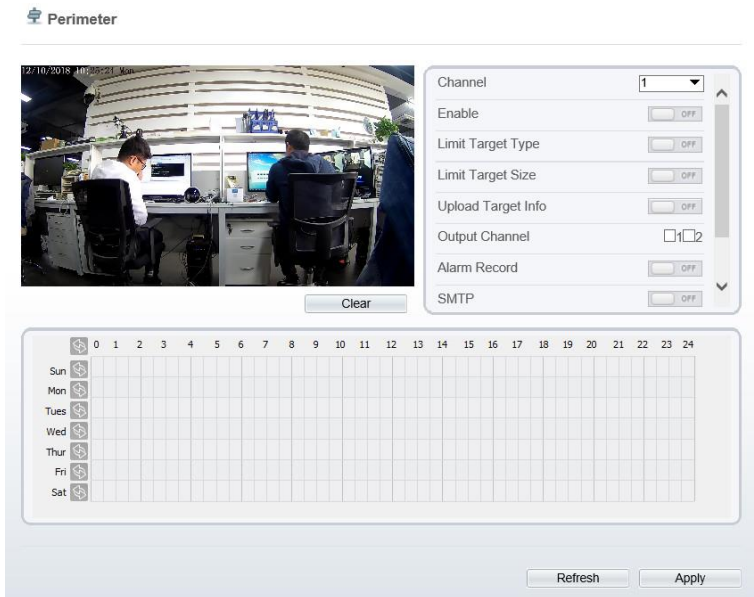

- Step 1 Select **Configuration > Intelligent Analysis > Perimeter** to access the **Perimeter** interface, as shown in Figure 6-1.

Figure 6-1 Perimeter Setting Interface



- Step 2 Set all parameters for perimeter. Table 6-1 describes the specific parameters.

Table 6-1 Perimeter Parameter Description

Parameter	Description	Setting
Channel	Channel 1: visible. Channel 2: thermal.	Choose one channel to set.
Enable	Enable the button to enable the alarm.	[How to set] Click Enable to enable. [Default value] OFF
Limit Target Type	Effective alarms are set based on target type, with options of Person or Car, person, car. When the device is used indoors, because of small space and large targets, to avoid wrong alarms are triggered b person even if car is selected, it is recommended to set the target type to person for indoor use.	[How to set] Click to enable Limit Target Type. [Default value] OFF
Limit Target Size	The target size for triggering an effective alarm is set based on the actual target size. The minimum size is 1000 square centimeters and the maximum100000 square centimeters. When setting the target size, you need to well set “Real size in scene” in advanced parameters; otherwise no alarms may be generated.	[How to set] Click to enable Limit Target Size. [Default configuration] OFF
Upload Target Info	Enable the function of uploading target information by clicking  below the real-time video in a browser to turn  into  . When an alarm is triggered, the target movement trace can be displayed (The trace can be seen only within the deployment area and disappears after the target leaves the deployment area).	[How to set] Click to enable Upload Target Info. [Default value] OFF

Parameter	Description	Setting
Output Channel	If you check to set the Output Channel and the device is connected to an external alarm indicator, the alarm indicator signals when an alarm is triggered.	[How to set] Click to select an ID.
Alarm Record	Enable the button to enable the alarm record.	[How to set] Click to enable Alarm Record. [Default value] OFF
SMTP	Enable the button to enable SMTP serve.	[How to set] Click to enable SMTP. [Default value] OFF
FTP Upload	Enable the button to enable File Transfer Protocol.	[How to set] Click to enable FTP Upload. [Default value] OFF
PTZ Type	Set PTZ type for dome cameras and select corresponding PTZ type: Preset/Scan/Track/Tour.	[How to set] Select from the drop-down list.
Value	Select corresponding value from value after select PTZ type.	[How to set] Select from the drop-down list.

Step 3 Set a deployment area. Move the cursor to the drawing interface and click to generate a point, move the cursor to draw a line, and then click to generate another point. This is how a line is generated. In this way, continue to draw lines to form any shape, and right-click to finish line drawing, as shown in Figure 6-2.

Figure 6-2 Deployment Area Setting Interface

 **NOTE**

- A drawn line cannot cross another one, or the line drawing fails.
- Any shape with 32 sides at most can be drawn.
- The quantity of deployment areas is not limited yet and will be described in future when a limit is applied.

Step 4 Set deployment time.

Method 1: Click left mouse button to select any time point within 0:00-24:00 from Monday to Sunday as shown in Figure 6-3.

Method 2: Hold down the left mouse button, drag and release mouse to select the deployment time within 0:00-24:00 from Monday to Sunday.

Method 3: Click  in the deployment time page to select the whole day or whole week.

 **NOTE**

- When you select time by dragging the cursor, the cursor cannot be moved out of the time area. Otherwise, no time can be selected.

Deleting deployment time: Click  again or inverse selection to delete the selected deployment time.

Figure 6-3 Deployment Time Setting Interface



----End

6.2 Single Virtual Fence

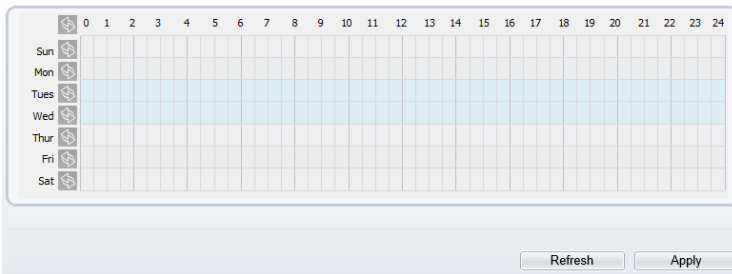
Description

A single virtual fence is a line that is set at a concerned position within the monitored field of view and specifies the forbidden travel direction; An alarm is generated when the targets of specified types (such as person or car) cross this line.

Procedure

Step 1 Select **Configuration > Intelligent Analysis > Single Virtual Fence** to access the **Single Virtual Fence** setting interface, as shown in Figure 6-4.

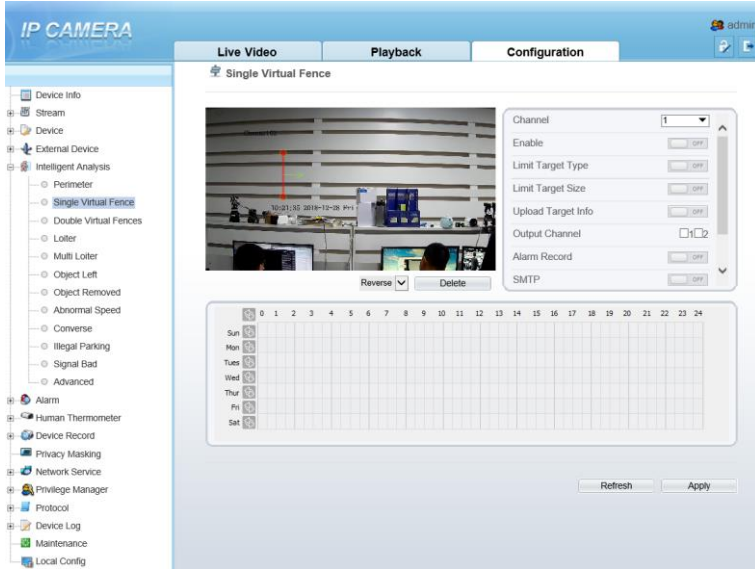

Figure 6-4 Single Virtual Fence Setting Interface



Step 2 Set all parameters for the single virtual fence. Table 6-2 describes the specific parameters.

Table 6-2 Parameters of single Virtual Fence

Parameter	Description	Setting
Enable	Enable the button to enable the alarm.	[How to set] Click Enable to enable. [Default value] OFF

Parameter	Description	Setting
Limit Target Type	Effective alarms are set based on target type, with options of Person or Car, person, car. When the device is used indoors, because of small space and large targets, alarms are triggered by person sometimes even if car is selected, leading to false alarms. It is recommended to set the target type to person for indoor use.	[How to set] Click to enable Limit Target Type. [Default value] OFF
Limit Target Size	The target size for triggering an effective alarm is set based on the actual target size. The minimum size is 1000 square centimeters and the maximum 100000 square centimeters. When setting the target size, you need to well set “Real size in scene” in advanced parameters, otherwise no alarms may be generated.	[How to set] Click to enable Limit Target Size. [Default configuration] OFF
Upload Target Info	Enable the function of uploading target information by clicking  below the real-time video in a browser to turn  into  . When an alarm is triggered, the target movement trace can be displayed (The trace can be seen only within the deployment area and disappears after the target leaves the deployment area).	[How to set] Click to enable Upload Target Info. [Default value] OFF
Output Channel	If you check to set the Output Channel and the device is connected to an external alarm indicator, the alarm indicator signals when an alarm is triggered.	[How to set] Click to select an ID.

Parameter	Description	Setting
Alarm Record	Enable the button to enable the alarm record.	[How to set] Click to enable Alarm Record. [Default value] OFF
SMTP	Enable the button to enable SMTP sever.	[How to set] Click to enable SMTP. [Default value] OFF
FTP Upload	Enable the button to enable File Transfer Protocol.	[How to set] Click to enable FTP. [Default value] OFF
PTZ Type	Set PTZ type for dome cameras and select corresponding PTZ type: Preset/Scan/Track/Tour.	[How to set] Select from the drop-down list.
Value	Select corresponding value from value after select PTZ type.	[How to set] Select from the drop-down list.

Step 3 Set a deployment area:

Draw a line: move the cursor to the drawing interface, hold down the left mouse button, and move the cursor to draw a line. When you release the left mouse button, a single virtual fence is generated.

Setting a single virtual fence: Click a line (and the trip line turns red) to select the single virtual fence and set its direction as Positive, Reverse or Bidirectional, or delete the selected line. You can also press and hold left mouse button at the endpoint of a single virtual fence and move the mouse to modify the position and length of this single virtual fence. You can right-click to delete the single virtual fence.

**NOTE**

- A single virtual fence is not within any deployment area, therefore, when an alarm is generated, the trace always exists. Only when the target object moves out of the field of view, the trace disappears.
- Try to draw the single virtual fence in the middle, because the recognition of a target takes time after target appearance on the screen and an alarm is generated only when the object is recognized to have crossed the single virtual fence.
- The single virtual fence which detects person foot as the recognition target cannot be too short, because a short single virtual fence tends to miss targets.
- Set deployment time. Details please refer to 5.1.1 Step 2.

----End

6.3 Double Virtual Fences

Description

Double virtual fences refer to two lines that are set at a concerned special position within the field of view and specify the forbidden travel direction. When the targets of specified types (such as person or car) move along the set travel direction and cross these lines in a certain order (line 1 followed by line 2) in pass max time, an alarm is generated.

Procedure

Step 1 Select **Configuration > Intelligent Analysis > Double Virtual Fences** to access the **Double Virtual Fences** setting interface, as shown in Figure 6-5.

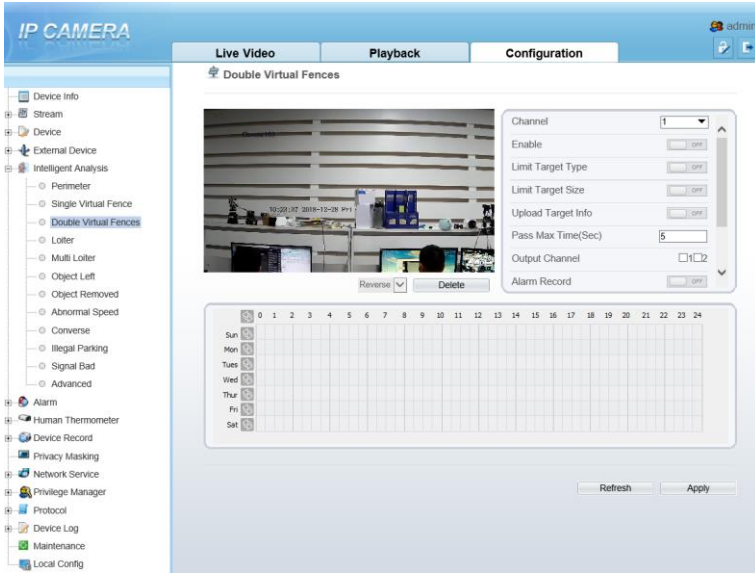

Figure 6-5 Double Virtual Fences Setting Interface



Step 2 Set all parameters for the double virtual fences. Table 6-3 describes the specific parameters.

Table 6-3 Description of Parameters for Double Virtual Fence

Parameter	Description	Setting
Enable	Enable the button to enable the alarm.	[How to set] Click Enable to enable. [Default value] OFF
Limit Target Type	Effective alarms are set based on target type, with options of Person or Car, person, car. When the device is used indoors, because of small space and large targets, alarms are triggered by person sometimes even if car is selected, leading to false alarms. It is recommended to set the target type to person for indoor use.	[How to set] Click to enable Limit Target Type. [Default value] OFF

Parameter	Description	Setting
Limit Target Size	The target size for triggering an effective alarm is set based on the actual target size. The minimum size is 1000 square centimeters and the maximum 100000 square centimeters. When setting the target size, you need to well set “Real size in scene” in advanced parameters, otherwise no alarms may be generated.	[How to set] Click to enable Limit Target Size. [Default configuration] OFF
Upload Target Info	Enable the function of uploading target information by clicking  below the real-time video in a browser to turn  into  . When an alarm is triggered, the target movement trace can be displayed (The trace can be seen only within the deployment area and disappears after the target leaves the deployment area).	[How to set] Click to enable Upload Target Info. [Default value] OFF
Pass Max Time (Sec)	An alarm is generated only when the time taken to cross the double virtual fences is less than the value. The default value is 10 seconds and the setting range is 1-60 seconds.	[How to set] Enter a value in the area box.
Output Channel	If you check to set the Output Channel and the device is connected to an external alarm indicator, the alarm indicator signals when an alarm is triggered.	[How to set] Click to select an ID.
Alarm Record	Enable the button to enable the alarm record.	[How to set] Click to enable Alarm Record. [Default value] OFF
SMTP	Enable the button to enable SMTP sever.	[How to set] Click to enable SMTP. [Default value] OFF

Parameter	Description	Setting
FTP Upload	Enable the button to enable File Transfer Protocol.	[How to set] Click to enable FTP. [Default value] OFF
PTZ Type	Set PTZ type for dome cameras and select corresponding PTZ type: Preset/Scan/Track/Tour.	[How to set] Select from the drop-down list.
Value	Select corresponding value from value after select PTZ type.	[How to set] Select from the drop-down list.

Step 3 Set a deployment area.

Draw a line: move the cursor to the drawing interface, hold down the left mouse button, and move the cursor to draw two lines. When you release the left mouse button, two numbered virtual fences are generated. Choose either of the double virtual fences to set the direction to Positive or Reverse.

Set double virtual fences: Click one of the double virtual fences (and the virtual fence turns red) to select this virtual fence and set the direction to **Positive** or **Reverse**, or delete the selected line. You can also press and hold left mouse button at the endpoint of a virtual fence and move the mouse to modify the position and length of this virtual fence. You can right-click to delete the double virtual fences.



NOTE

- The two virtual fences are in sequential order. An alarm is generated only when a target crosses virtual fence 1 and then virtual fence 2 within the set maximum passing time.
- The double virtual fences are not within any deployment area, therefore, when an alarm is generated, the trace always exists. Only when the target object moves out of the field of view, the trace disappears.
- Try to draw double virtual fences in the middle, because the recognition of a target takes time after target appearance on the screen and an alarm is generated only when the object is recognized to have crossed the double virtual fences.
- The double virtual fences which detect person foot as the recognition target cannot be too short, because short double virtual fences tend to miss targets.

Step 4 Set deployment time. Details please refer to 5.1.1 Step 2 .

----End

6.4 Loiter

Description

Loiter allows setting the shortest loitering time for a (single) target of specified type (such as person or car) within the deployment area in the field of view. When the loitering time of a (single) target within this area meets the set shortest loitering time, an alarm is generated.

Procedure

Step 1 Select Configuration > Intelligent Analysis > Loiter to access the Loiter setting interface, as shown in Figure 6-6.

Figure 6-6 Loiter Setting Interface

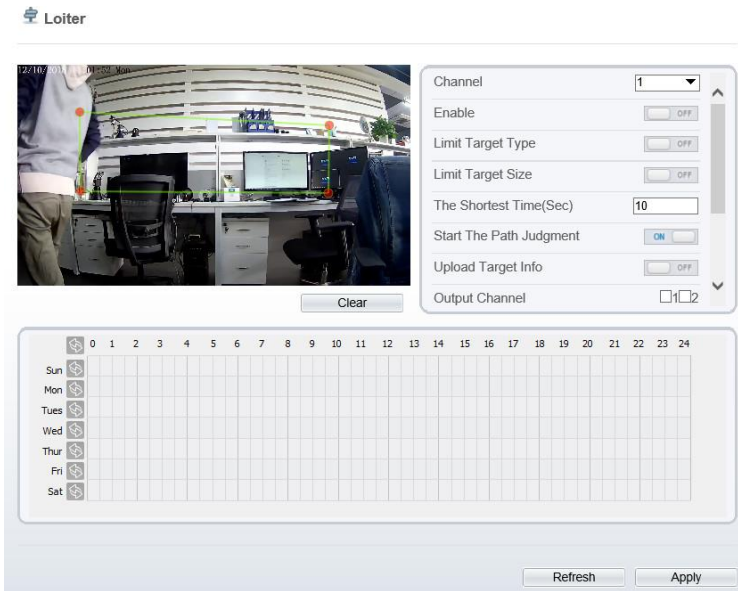



Step 2 Set all parameters for loitering. Table 6-4 describes the specific parameters.

Table 6-4 Loitering Parameter Description

Parameter	Description	Setting
Enable	Enable the button to enable the alarm.	[How to set] Click Enable to enable. [Default value] OFF

Parameter	Description	Setting
Limit Target Type	Effective alarms are set based on target type, with options of Person or Car, person, car. When the device is used indoors, because of small space and large targets, alarms are triggered by person sometimes even if car is selected, leading to false alarms. It is recommended to set the target type to person for indoor use.	[How to set] Click to enable Limit Target Type. [Default value] OFF
Limit Target Size	The target size for triggering an effective alarm is set based on the actual target size. The minimum size is 1000 square centimeters and the maximum 100000 square centimeters. When setting the target size, you need to well set “Real size in scene” in advanced parameters, otherwise no alarms may be generated.	[How to set] Click to enable Limit Target Size. [Default configuration] OFF
The Shortest Time (Sec)	The time that a target object spends in loitering cannot be less than the shortest loitering time. Setting range: 5-60 seconds.	[How to set] Enter a value in the area box. [Default value] 10s
Start the Path Judgment	The enabling of path analysis makes loitering judgment accurate by using the software algorithm, for example, no alarm is generated when a person walks along a straight line if the button set ON .	[How to set] Click to enable Start the Path Judgment and enable path analysis.

Parameter	Description	Setting
Upload Target Info	Enable the function of uploading target information by clicking  below the real-time video in a browser to turn  into  . When an alarm is triggered, the target movement trace can be displayed (The trace can be seen only within the deployment area and disappears after the target leaves the deployment area).	[How to set] Click to enable Upload Target Info. [Default value] OFF
Output Channel	If you check to set the Output Channel and the device is connected to an external alarm indicator, the alarm indicator signals when an alarm is triggered.	[How to set] Click to select an ID.
Alarm Record	Enable the button to enable the alarm record.	[How to set] Click to enable Alarm Record. [Default value] OFF
SMTP	Enable the button to enable SMTP sever.	[How to set] Click to enable SMTP. [Default value] OFF
FTP Upload	Enable the button to enable File Transfer Protocol.	[How to set] Click to enable FTP. [Default value] OFF
PTZ Type	Set PTZ type for dome cameras and select corresponding PTZ type: Preset/Scan/Track/Tour.	[How to set] Select from the drop-down list.
Value	Select corresponding value from Value after select PTZ type.	[How to set] Select from the drop-down list.

Step 3 Set a deployment area. Move the cursor to the drawing interface and click to generate a point, move the cursor to draw a line, and then click to generate another point. This is how a line is generated. In this way, continue to draw lines to form any shape, and right-click to finish line drawing.

**NOTE**

- A drawn line cannot cross another one, or the line drawing fails.
- Any shape with 32 sides at most can be drawn.
- The quantity of deployment areas is not limited yet and will be described in future when a limit is applied.

Step 4 Set deployment time. Details please refer to 5.1.1 Step 2

----End

6.5 Multiple Loiter

Description

Multiple loiter allows setting the shortest loitering time for multiple targets of specified type (such as person or car) within the deployment area in the field of view. When the loitering time of the multiple targets within this area meets the set shortest loitering time, an alarm is generated.

Procedure

Step 1 Select **Configuration > Intelligent Analysis > Multi Loiter** to access the **Multi Loiter** setting interface, as shown in Figure 6-7.

Figure 6-7 Multi Loiter Setting Interface

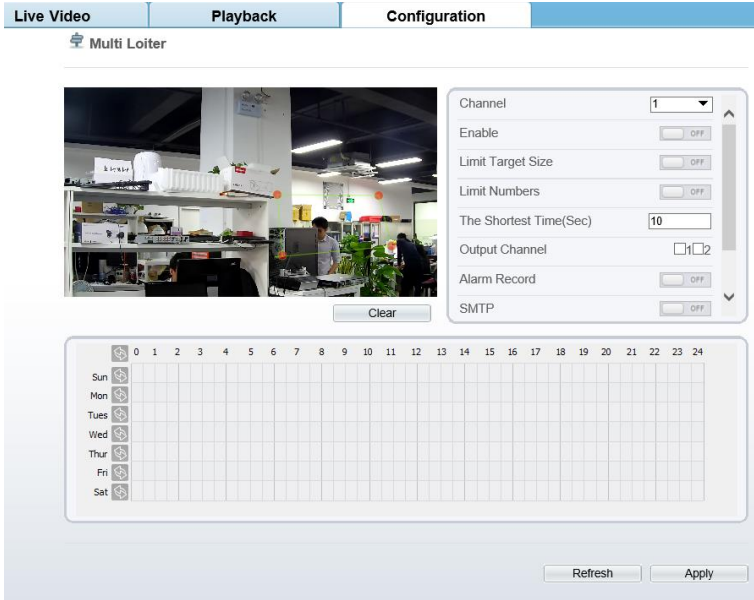

Step 2 Set all parameters for multiple loitering. Table 1-1 describes the specific parameters.

Table 1-1 Multiple Loitering Parameter Description

Parameter	Description	Setting
Enable	Enable the button to enable the alarm.	[How to set] Click to enable Enable. [Default value] OFF
Limit Target Size	The target size for triggering an effective alarm is set based on the actual target size. The minimum size is 1000 square centimeters and the maximum 100000 square centimeters. When setting the target size, you need to well set “Real size in scene” in advanced parameters, otherwise no alarms may be generated.	[How to set] Click to enable Limit Target Size. [Default configuration] OFF

Parameter	Description	Setting
Limit Numbers	When Limit Numbers is set to OFF, an alarm is generated no matter how many people loiter. When Limit Numbers is set to ON, if the minimum number is set to 2 and the maximum number is set to 3, an alarm is generated for 2-3 people loitering. Other settings are the same as loitering.	[How to set] Click to enable Limit Numbers.
The Shortest Time (Sec)	The time that a target object spends in loitering cannot be less than the shortest loitering time. Setting range: 5-60 seconds.	[How to set] Enter a value in the area box. [Default value] 10s
Output Channel	If you check to set the Output Channel and the device is connected to an external alarm indicator, the alarm indicator signals when an alarm is triggered.	[How to set] Click to select an ID.
Alarm Record	Enable the button to enable the alarm record.	[How to set] Click to enable Alarm Record. [Default value] OFF
SMTP	Enable the button to enable SMTP sever.	[How to set] Click to enable SMTP. [Default value] OFF
FTP Upload	Enable the button to enable File Transfer Protocol.	[How to set] Click to enable FTP Upload. [Default value] OFF
PTZ Type	Set PTZ type for dome cameras and select corresponding PTZ type: Preset/Scan/Track/Tour.	[How to set] Select from the drop-down list.
Value	Select corresponding value from Value after select PTZ type.	[How to set] Select from the drop-down list.

Step 3 Set a deployment area:

Move the cursor to the drawing interface and click to generate a point, move the cursor to draw a line, and then click to generate another point. This is how a line is generated. In this way, continue to draw lines to form any shape, and right-click to finish line drawing.

**NOTE**

- A drawn line cannot cross another one, or the line drawing fails. Any shape with 32 sides at most can be drawn.
- The quantity of deployment areas is not limited yet and will be described in future when a limit is applied.

Step 4 Set deployment time. Details please refer to 5.1.1 Step 2

---End

6.6 Object Left

Description

The object left function refers to that an alarm is generated when the dwelling time of an object within the deployment area meets the set shortest dwelling time.

Procedure

Step 1 Select **Configuration > Intelligent Analysis > Object Left** to access the **Object Left** setting interface, as shown in Figure 6-8.

Figure 6-8 Object Left Setting Interface

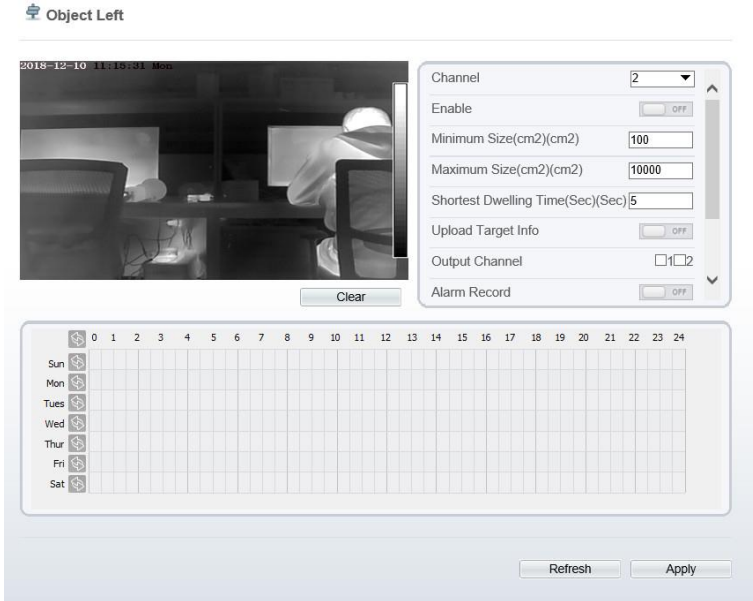

Step 2 Set all parameters for object left.

Step 3 Set a deployment area. Move the cursor to the drawing interface and click to generate a point, move the cursor to draw a line, and then click to generate another point. This is how a line is generated. In this way, continue to draw lines to form any shape, and right-click to finish line drawing.

NOTE

- A drawn line cannot cross another one, or the line drawing fails.
- Any shape with 32 sides at most can be drawn.
- The quantity of deployment areas is not limited yet and will be described in future when a limit is applied.

Step 4 Set deployment time . Details please refer to 5.1.1 Step 2

---End

6.7 Object Removed

Description

The object removed function refers to that an alarm is generated when the removing time of an object within the deployment area meets the set shortest removing time.

Procedure

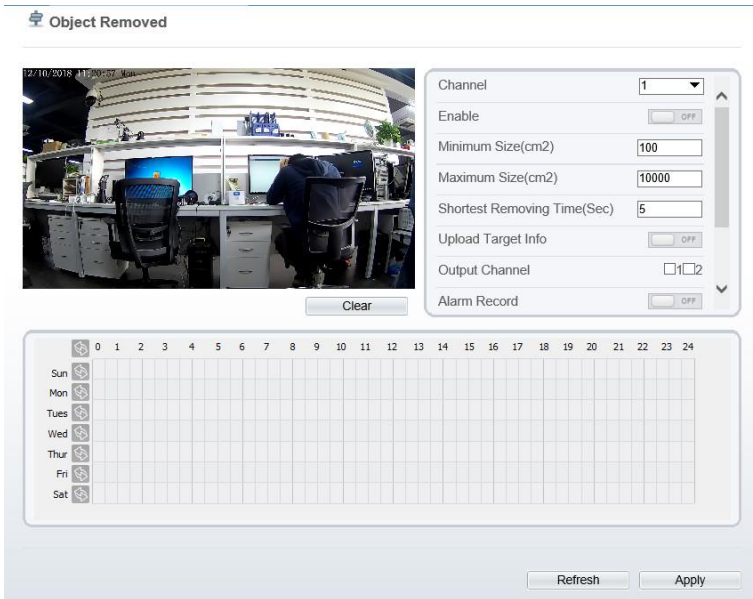

- Step 1 Select **Configuration > Intelligent Analysis > Object Removed** to access the **Object Removed** setting interface, as shown in Figure 6-9.

Figure 6-9 Object Removed Setting Interface Setting Interface



- Step 2 Set all parameters for object removed. Table 1-2 describes the specific parameters.

Table 1-2 Description of Parameters for Object Removed

Parameter	Description	Setting
Enable	Enable the button to enable the alarm.	[How to set] Click Enable to enable. [Default value] OFF
Minimum (Maximum) Size(cm ²)	The target size for triggering an effective alarm is set based on the actual target size. The minimum size is 100 square centimeters and the maximum 10000 square centimeters. When setting the target size, you need to well set “Real size in scene” in advanced parameters; otherwise no alarms may be generated.	[How to set] Enter a value in the area box.
Shortest Removing Time (Sec)	An alarm is generated when the object removed time is longer than the shortest removing time. Setting range: 5-60 seconds.	[How to set] Enter a value in the area box. [Default value] 5s
Upload Target Info	Enable the function of uploading target information by clicking  below the real-time video in a browser to turn  into  . When an alarm is triggered, the target movement trace can be displayed (The trace can be seen only within the deployment area and disappears after the target leaves the deployment area).	[How to set] Click to enable Upload Target Info. [Default value] OFF
Output Channel	If you check to set the Output Channel and the device is connected to an external alarm indicator, the alarm indicator signals when an alarm is triggered.	[How to set] Click to select an ID.
Alarm Record	Enable the button to enable the alarm record.	[How to set] Click to enable Alarm Record. [Default value] OFF

Parameter	Description	Setting
SMTP	Enable the button to enable SMTP sever.	[How to set] Click to enable SMTP. [Default value] OFF
FTP Upload	Enable the button to enable File Transfer Protocol.	[How to set] Click to enable FTP Upload. [Default value] OFF
PTZ Type	Set PTZ type for dome cameras and select corresponding PTZ type: Preset/Scan/Track/Tour.	[How to set] Select from the drop-down list.
Value	Select corresponding value from Value after select PTZ type.	[How to set] Select from the drop-down list.

Step 3 Set a deployment area. Move the cursor to the drawing interface and click to generate a point, move the cursor to draw a line, and then click to generate another point. This is how a line is generated. In this way, continue to draw lines to form any shape, and right-click to finish line drawing.



NOTE

- A drawn line cannot cross another one, or the line drawing fails.
- Any shape with 32 sides at most can be drawn.
- The quantity of deployment areas is not limited yet and will be described in future when a limit is applied.

Step 4 Set deployment time. Details please refer to 5.1.1 Step 2

----End

6.8 Abnormal Speed

Description

Abnormal speed allows setting the travel speed criteria for a target within the deployment area on the video screen. When the travel speed of a target of specified type (such as person or car) within this area meets the alarm condition, an alarm is generated.

Procedure

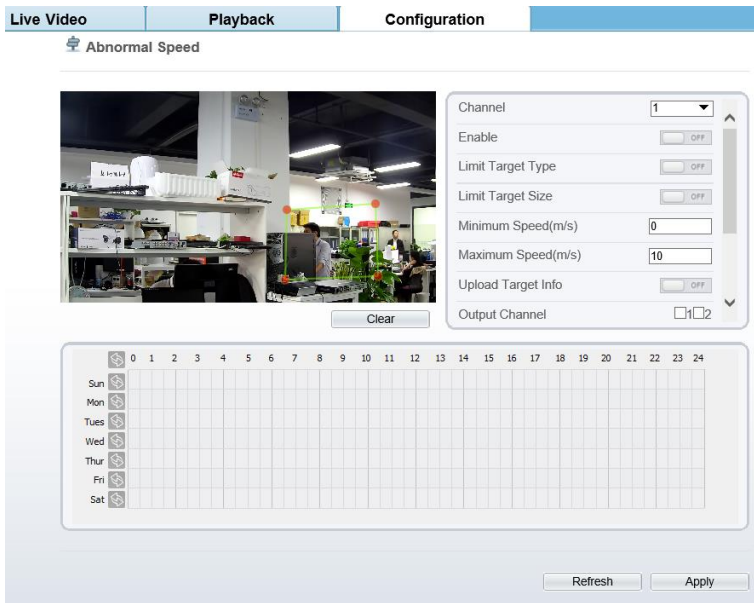

Step 1 Select **Configuration > Intelligent Analysis > Abnormal Speed** to access the **Abnormal Speed** setting interface, as shown in Figure 6-10.

Figure 6-10 Abnormal Speed Setting Interface



Step 2 Set all parameters for the abnormal speed. Table 1-3 describes the specific parameters.

Table 1-3 Description of Parameters for Abnormal Speed

Parameter	Description	Setting
Enable	Enable the button to enable the alarm.	[How to set] Click to enable Enable. [Default value] OFF
Limit Target Type	Effective alarms are set based on target type, with options of Person or Car, person, car. When the device is used indoors, because of small space and large targets, alarms are triggered by person sometimes even if car is selected, leading to false alarms. It is recommended to set the target type to person for indoor use.	[How to set] Click to enable Limit Target Type. [Default value] OFF
Limit Target Size	The target size for triggering an effective alarm is set based on the actual target size. The minimum size is 1000 square centimeters and the maximum 100000 square centimeters. When setting the target size, you need to well set “Real size in scene” in advanced parameters, otherwise no alarms may be generated.	[How to set] Click to enable Limit Target Size. [Default configuration] OFF
Minimum (Maximum) Speed (m/s)	Set prohibited speeds. When a target object crosses an area at a speed between the minimum and maximum speeds, an alarm is generated. Setting range: 0-10 m/s.	[How to set] Enter a value in the area box.
Upload Target Info	Enable the function of uploading target information by clicking  below the real-time video in a browser to turn  into  . When an alarm is triggered, the target movement trace can be displayed (The trace can be seen only within the deployment area and disappears after the target leaves the deployment area).	[How to set] Click to enable Upload Target Info. [Default value] OFF

Parameter	Description	Setting
Output Channel	If you check to set the Output Channel and the device is connected to an external alarm indicator, the alarm indicator signals when an alarm is triggered.	[How to set] Click to select an ID.
Alarm Record	Enable the button to enable the alarm record.	[How to set] Click to enable Alarm Record. [Default value] OFF
SMTP	Enable the button to enable SMTP sever.	[How to set] Click to enable SMTP. [Default value] OFF
FTP Upload	Enable the button to enable File Transfer Protocol.	[How to set] Click to enable FTP Upload. [Default value] OFF
PTZ Type	Set PTZ type for dome cameras and select corresponding PTZ type: Preset/Scan/Track/Tour.	[How to set] Select from the drop-down list.
Value	Select corresponding value from Value after select PTZ type.	[How to set] Select from the drop-down list.

Step 3 Set a deployment area. Move the cursor to the drawing interface and click to generate a point, move the cursor to draw a line, and then click to generate another point. This is how a line is generated. In this way, continue to draw lines to form any shape, and right-click to finish line drawing.

NOTE

- A drawn line cannot cross another one, or the line drawing fails.
- Any shape with 32 sides at most can be drawn.

- The quantity of deployment areas is not limited yet and will be described in future when a limit is applied.

Step 4 Set deployment time. Details please refer to 5.1.1 Step 2.

----End

6.9 Converse

Description

Converse allows setting the travel direction criteria for a target within an area on the video screen. When a target of specified type (such as people or car) within this area moves in the set travel direction, an alarm is generated.

Procedure

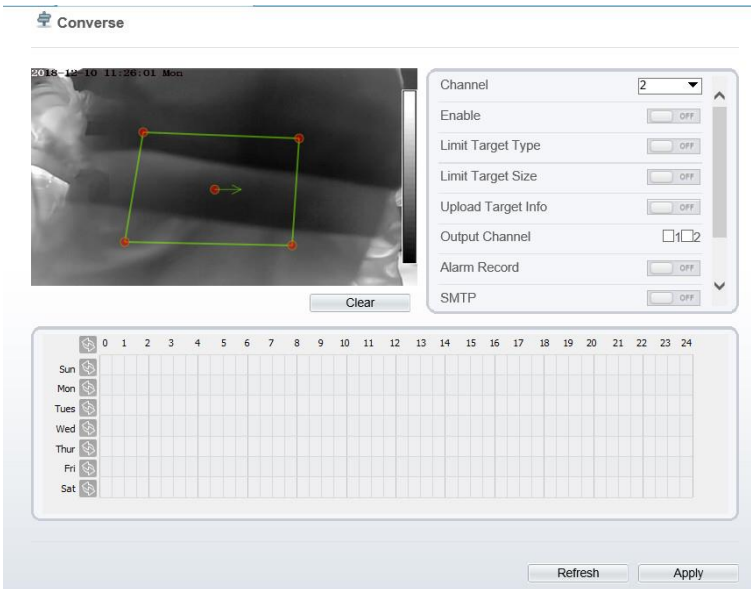

Step 1 Select **Configuration > Intelligent Analysis > Converse** to access the **Converse** setting interface, as shown in Figure 6-11.

Figure 6-11 Converse Setting Interface



Step 2 Set all parameters for converse. Table 1-4 describes the specific parameters.

Table 1-4 Converse Parameter Description

Parameter	Description	Setting
Enable	Enable the button to enable the alarm.	[How to set] Click to enable Enable. [Default value] OFF
Limit Target Type	Effective alarms are set based on target type, with options of Person or Car, person, car. When the device is used indoors, because of small space and large targets, alarms are triggered by person sometimes even if car is selected, leading to false alarms. It is recommended to set the target type to person for indoor use.	[How to set] Click to enable Limit Target Type. [Default value] OFF
Limit Target Size	The target size for triggering an effective alarm is set based on the actual target size. The minimum size is 1000 square centimeters and the maximum 100000 square centimeters. When setting the target size, you need to well set "Real size in scene" in advanced parameters, otherwise no alarms may be generated.	[How to set] Click to enable Limit Target Size. [Default configuration] OFF
Upload Target Info	Enable the function of uploading target information by clicking  below the real-time video in a browser to turn  into  . When an alarm is triggered, the target movement trace can be displayed (The trace can be seen only within the deployment area and disappears after the target leaves the deployment area).	[How to set] Click to enable Upload Target Info. [Default value] OFF
Output Channel	If you check to set the Output Channel and the device is connected to an external alarm indicator, the alarm indicator signals when an alarm is triggered.	[How to set] Click to select an ID.

Parameter	Description	Setting
Alarm Record	Enable the button to enable the alarm record.	[How to set] Click to enable Alarm Record. [Default value] OFF
SMTP	Enable the button to enable SMTP sever.	[How to set] Click to enable SMTP. [Default value] OFF
FTP Upload	Enable the button to enable File Transfer Protocol.	[How to set] Click to enable FTP Upload. [Default value] OFF
PTZ Type	Set PTZ type for dome cameras and select corresponding PTZ type: Preset/Scan/Track/Tour.	[How to set] Select from the drop-down list.
Value	Select corresponding value from Value after select PTZ type.	[How to set] Select from the drop-down list.

Step 3 Set a deployment area. Move the cursor to the drawing interface and click to generate a point, move the cursor to draw a line, and then click to generate another point. This is how a line is generated. In this way, continue to draw lines to form any shape, and right-click to finish line drawing, move the arrow in the field can set the direction of converse.



NOTE

- A drawn line cannot cross another one, or the line drawing fails.
- Any shape with 32 sides at most can be drawn.
- The quantity of deployment areas is not limited yet and will be described in future when a limit is applied

Step 4 Set deployment time. Details please refer to 5.1.1 Step 2

----End

6.10 Illegal Parking

Description

Illegal parking allows setting the dwelling time criteria for a target within the deployment area on the video screen. When the dwelling time of a target of specified type (car) within this area meets the set allowed parking time, an alarm is generated.

Procedure

- Step 1 Select **Configuration > Intelligent Analysis > Illegal Parking** to access the **Illegal Parking** setting interface, as shown in Figure 6-12.

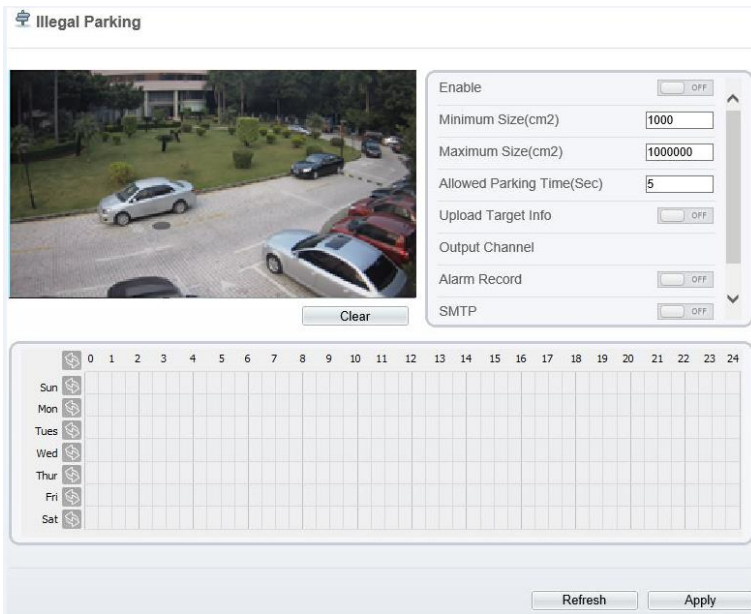

Figure 6-12 Illegal Parking Setting Interface



- Step 2 Set all parameters for illegal parking. Table 6-5 describes the specific parameters.

Table 6-5 Parameters of Illegal Parking

Parameter	Description	Setting
Enable	Enable the button to enable the alarm.	[How to set] Click to enable Enable. [Default value] OFF

Parameter	Description	Setting
Minimum (Maximum) Size(cm ²)	The target size for triggering an effective alarm is set based on the actual target size. The default value is minimum size is 1000square centimeters and the maximum size is 1000000 square centimeters. When setting the target size, you need to well set “Real size in scene” in advanced parameters, otherwise no alarms may be generated.	[How to set] Enter a value in the area box.
Allowed parking time(Sec)	An alarm is generated when the object left time is longer than the shortest dwelling time. Setting range: 5-60 seconds.	[How to set] Enter a value in the area box. [Default value] 5
Upload Target Info	Enable the function of uploading target information by clicking  below the real-time video in a browser to turn  into  . When an alarm is triggered, the target movement trace can be displayed (The trace can be seen only within the deployment area and disappears after the target leaves the deployment area).	[How to set] Click to enable Upload Target Info. [Default value] OFF
Output Channel	If you check to set the Output Channel and the device is connected to an external alarm indicator, the alarm indicator signals when an alarm is triggered.	[How to set] Click to select an ID.
Alarm Record	Enable the button to enable the alarm record.	[How to set] Click to enable Alarm Record. [Default value] OFF
SMTP	Enable the button to enable SMTP sever.	[How to set] Click to enable SMTP. [Default value] OFF

Parameter	Description	Setting
FTP Upload	Enable the button to enable File Transfer Protocol.	[How to set] Click to enable FTP Upload. [Default value] OFF
PTZ Type	Set PTZ type for dome cameras and select corresponding PTZ type: Preset/Scan/Track/Tour.	[How to set] Select from the drop-down list.
Value	Select corresponding value from Value after select PTZ type.	[How to set] Select from the drop-down list.

Step 3 Set a deployment area. Move the cursor to the drawing interface and click to generate a point, move the cursor to draw a line, and then click to generate another point. This is how a line is generated. In this way, continue to draw lines to form any shape, and right-click to finish line drawing, as shown in Figure 6-13

Figure 6-13 Deployment Area Setting Interface



NOTE

- A drawn line cannot cross another one, or the line drawing fails.
- Any shape with 32 sides at most can be drawn.
- The quantity of deployment areas is not limited yet and will be described in future when a limit is applied.

Step 4 Set deployment time

Details please refer to 5.1.1 Step 2

----End

6.11 Signal Bad

Description

Signal bad refers to that an alarm is generated if an event such as tampered or shifted occurs.

NOTE

- Currently, an alarm is generated only when more than 75% area of a video is obscured.
- When the ambient is dark and the gray average is less than 40, an alarm of Signal Bad is generated.

Procedure

Step 1 Select **Configuration > Intelligent Analysis > Signal Bad** to access the **Signal Bad** setting interface, as shown in Figure 6-14.

Figure 6-14 Signal Bad Setting Interface

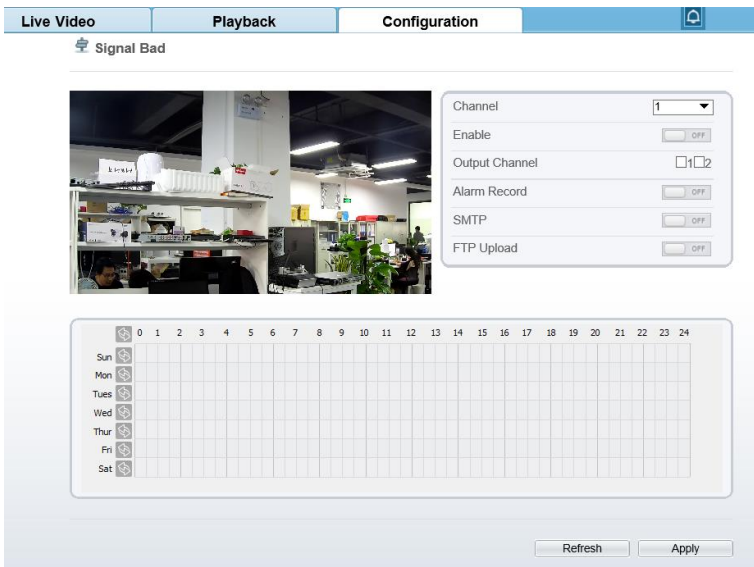

Step 2 Set all parameters for signal bad. Table 6-6 describes the specific parameters.

Table 6-6 Description of Parameters for Signal Bad

Parameter	Description	Setting
Enable	Enable the button to enable the alarm.	[How to set] Click Enable to enable. [Default value] OFF
Output Channel	If you check to set the Output Channel and the device is connected to an external alarm indicator, the alarm indicator signals when an alarm is triggered.	[How to set] Click to select an ID.
Alarm Record	Enable the button to enable the alarm record.	[How to set] Click to enable Alarm Record. [Default value] OFF
PTZ Type	Set PTZ type for dome cameras and select corresponding alarm name. The linkage alarm is enabled when an intrusion alarm is triggered.	[How to set] Select from the drop-down list.
Value	Select corresponding value from Value after select PTZ type.	[How to set] Select from the drop-down list.

Step 3 Set deployment time, details please refer to 5.1.1 Step 2.

----End

7 Alarm Setting

7.1 Alarm Output

Procedure

Step 1 Select **Configuration > alarm > alarm output** to access the **alarm output** setting interface, as shown in Figure 7-1.

Figure 7-1 Alarm output interface

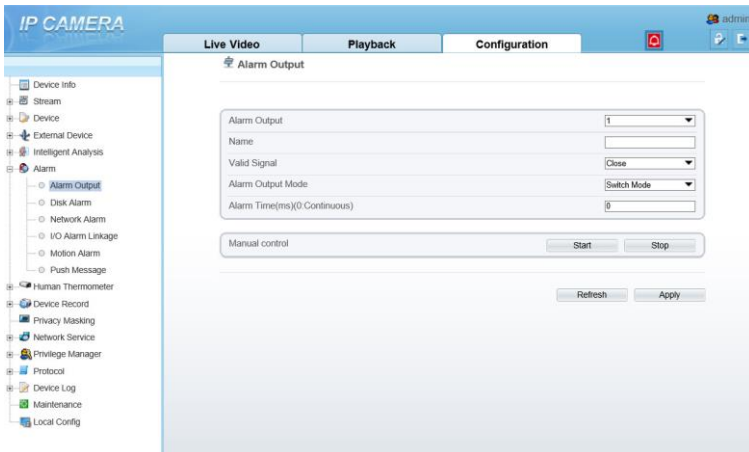

Step 2 Set alarm output of channel, name, enable valid signal and alarm time choose alarm output mode.

Step 3 You can also control alarm manually, click start button to start alarm, click stop button to end the alarm .

7.2 Disk Alarm

Procedure

Step 1 Select **Configuration > alarm > disk alarm** to access the disk alarm setting interface, as shown in Figure 7-2.

Figure 7-2 Disk alarm interface

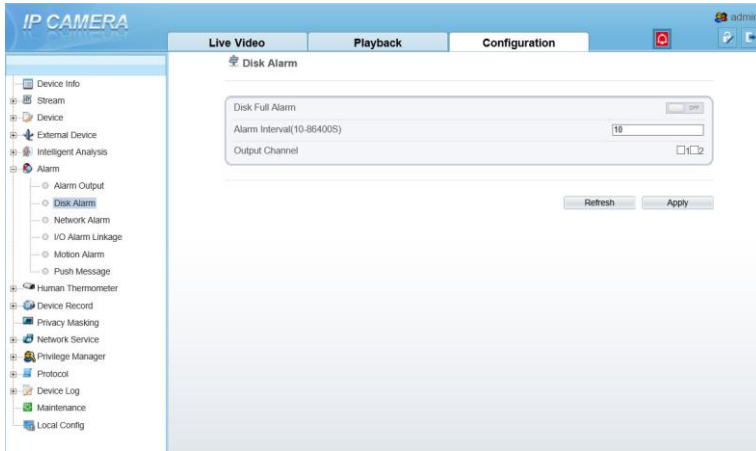

Step 2 Enable the disk full alarm. Set alarm interval , the value is from 10 to 86400s.

Step 3 Tick the channel to push alarm message.

Step 4 Click **apply** to save the settings, click **refresh** will return last settings.

7.3 Network Alarm

Procedure

Step 1 Select **Configuration > alarm > network alarm** to access the network alarm setting interface, as shown in Figure 7-3.

Figure 7-3 Network alarm interface

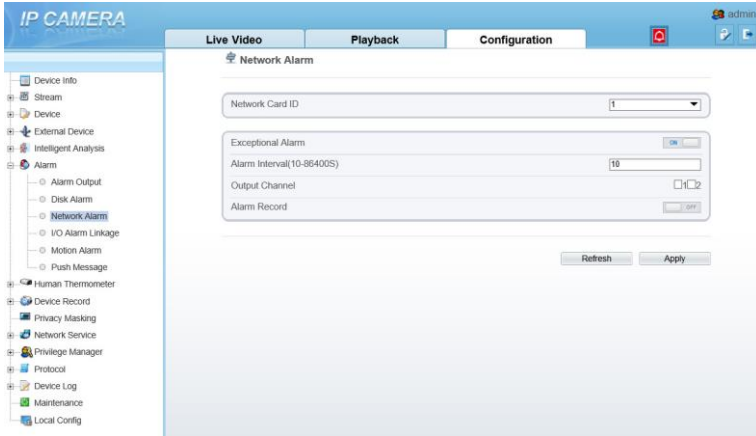

- Step 2 Choose network card ID and enable exceptional alarm to set alarm interval. Tick output channel.
- Step 3 Enable the alarm record.
- Step 4 Click apply to save the settings, click refresh will return last settings.

7.4 I/O Alarm Linkage

Procedure

- Step 1 Select **Configuration > alarm > I/O alarm linkage** to access the **I/O alarm linkage** setting interface, as shown in Figure 7-4.

Figure 7-4 I/O alarm linkage interface

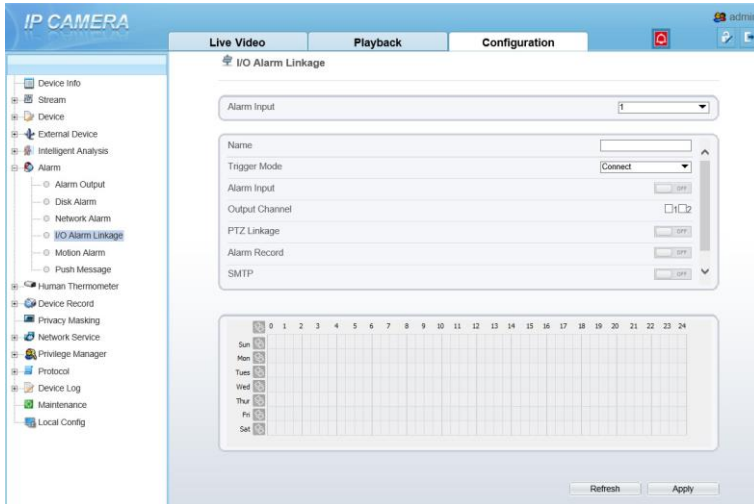

- Step 2 Choose alarm input and trigger mode, set name, enable other linkages such as alarm input, PTZ linkage, alarm record, SMTP and FTP upload.
- Step 3 Set alarm schedule, choose the duration of linkage.
- Step 4 Click apply to save the settings, click refresh will return last settings.

7.5 Motion Alarm

Procedure

- Step 1 Select **Configuration > alarm > motion alarm** to access the **motion alarm** setting interface, as shown in Figure 7-5.

Figure 7-5 Motion alarm interface

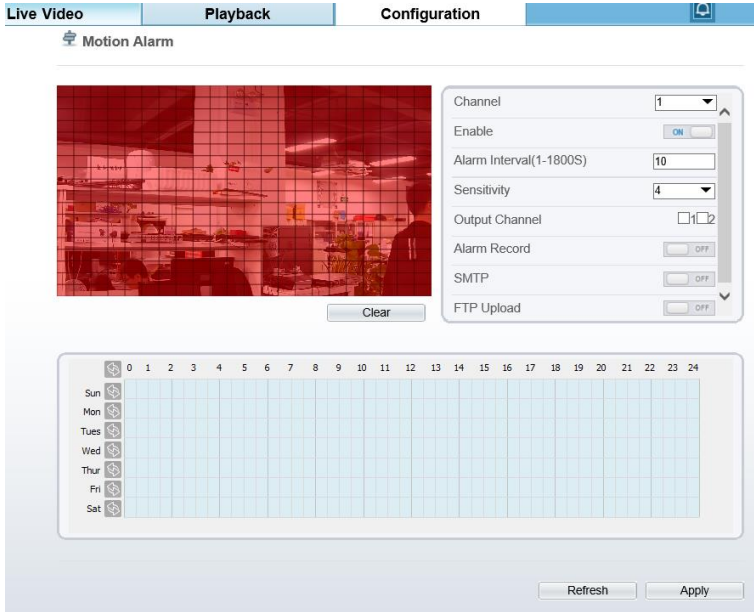

- Step 2 Choose channel and enable the motion alarm, set alarm interval and sensitivity, enable other linkages such as alarm record, SMTP and FTP upload.
- Step 3 Set motion alarm schedule,
- Step 4 Click **apply** to save the settings, click **refresh** will return last settings.

7.6 Push Message

Procedure

- Step 1 Select **Configuration > alarm > push message** to access the **push message** setting interface, as shown in Figure 7-6.

Figure 7-6 Push message interface

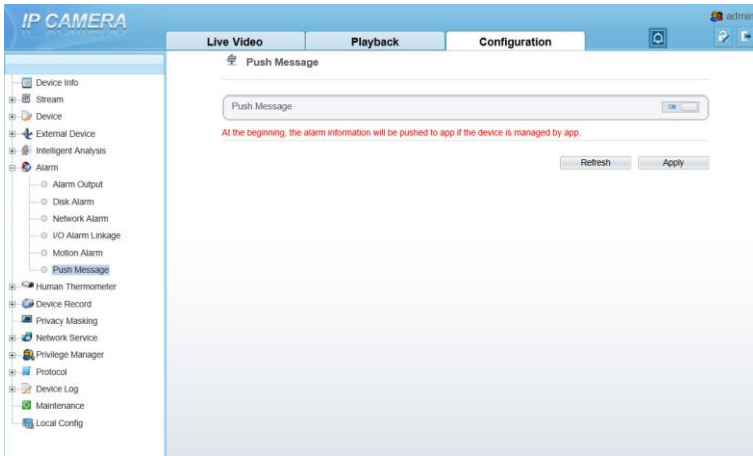

Step 2 Enable the push message, you will receive the message when the alarm happened.

Step 3 Click **apply** to save the settings, click **refresh** will return last settings.

8 Other Web Configurations

8.1 Device Information

You can view the information about device, as shown in Figure 8-1.

Figure 8-1 Device information interface

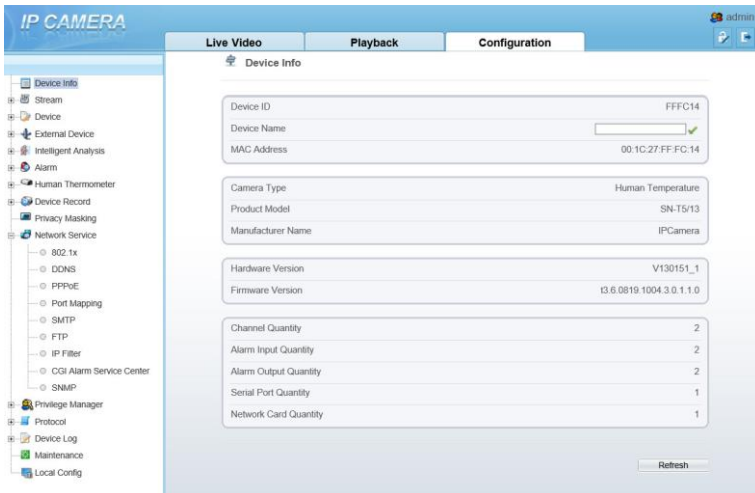

8.2 Stream

8.2.1 Base Stream

Step 1 Choose **configuration >stream >base stream**, as shown in Figure 8-2.

Figure 8-2 Base stream interface

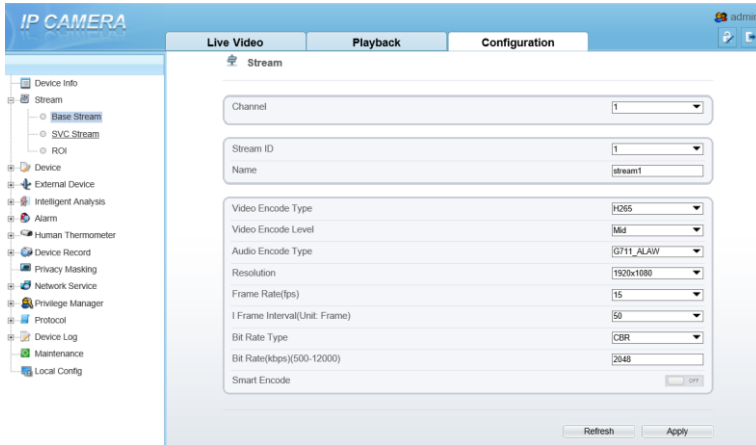

- Step 2 Choose channel, stream ID, video encode type, video encode level, audio encode type, resolution, frame rate, frame interval, bit rate type and bit rate from all drop list.
- Step 3 Set name of base stream, enable smart encode.
- Step 4 Click **Apply**. The message "**Apply success**" is displayed, the system saves the settings.

8.2.2 SVC Stream

- Step 1 Choose **configuration >stream >base stream**, as shown in Figure 8-3.

Figure 8-3 SVC stream interface

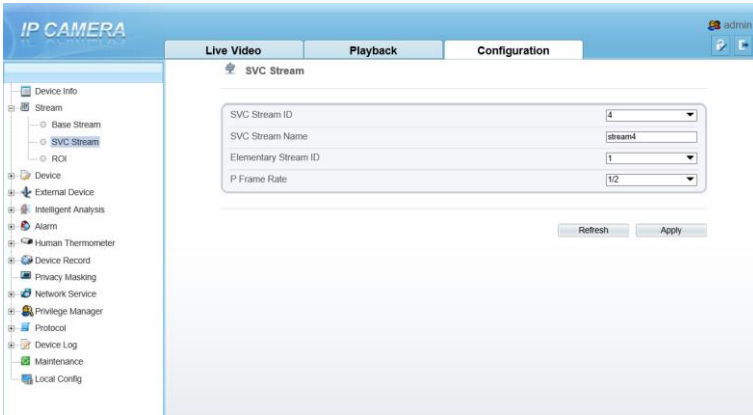

- Step 2 Choose SVC stream ID, elementary stream ID and P frame rate from drop list.
- Step 3 Click **Apply**. The message "Apply success" is displayed, the system saves the settings.

8.2.3 ROI

- Step 1 Choose **configuration >stream >ROI**, as shown in Figure 8-4.

Figure 8-4 ROI interface

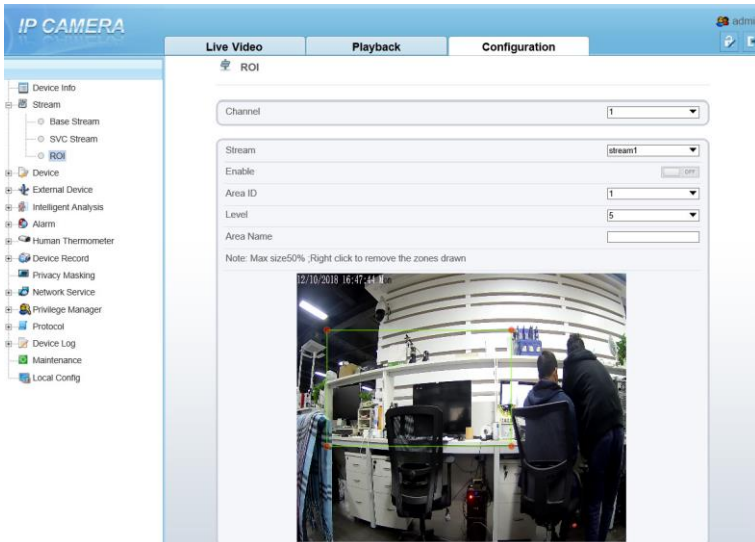

Step 2 Click **Apply**. The message "**Apply success**" is displayed, the system saves the settings.

8.3 Device

You can set local network, device port, data and time, camera, OSD, microphone, CVBS, system, voice denoise and software licenses, as shown in Figure 8-5.

Figure 8-5 Device interface

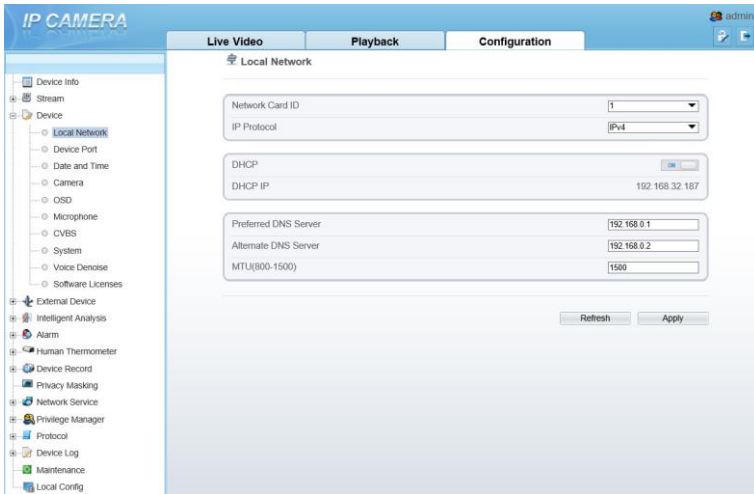

8.4 External Device

Choose **configuration > external device**, enable PTZ, set parameters as shown in Figure 8-6.

Figure 8-6 External device interface

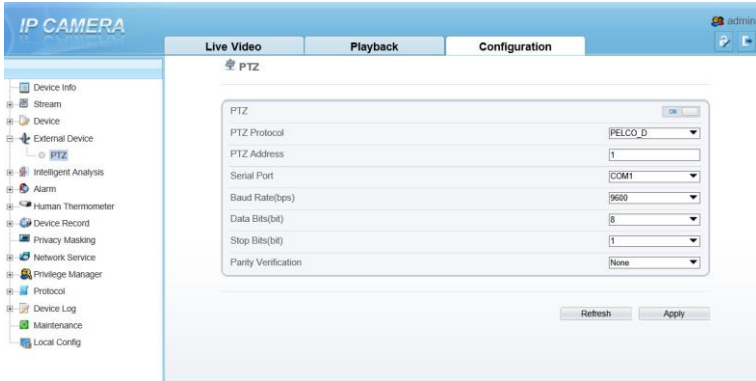

8.5 Device Record

Choose **configuration > device record**, enable **schedule record**, set post record, record audio, record rule(cycle store or save days) and stream name. At this interface, you can also view or modify the information of **record directory**.

Figure 8-7 Device record interface

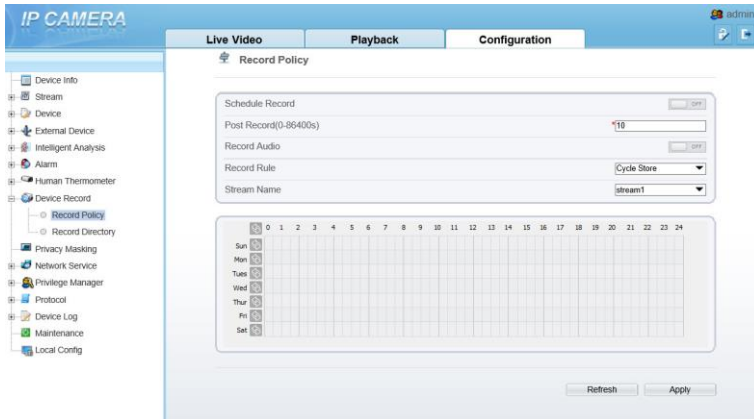

8.6 Privacy Masking

Choose **configuration > privacy masking**. You can set privacy masking if some area need keep secret, drag mouse to select the area to cover, double click will delete the setting, as shown in Figure 8-8.

Figure 8-8 Privacy masking interface

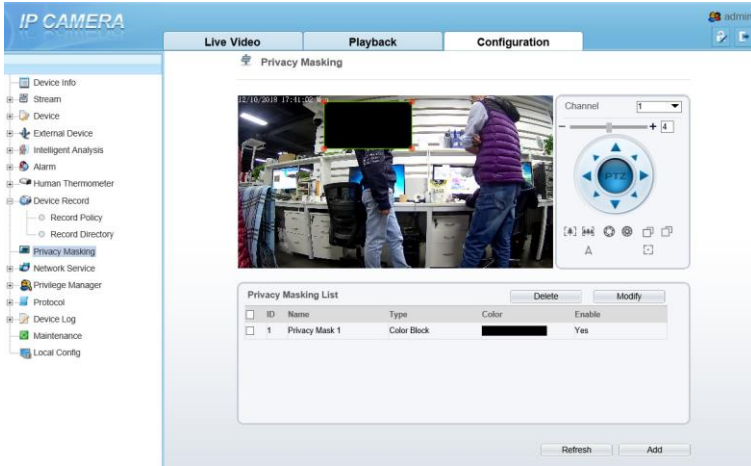

8.7 Network Service

Choose **configuration > network service**. You can set **802.1x**, **DDNS**, **PPPoE**, **Port mapping**, **SMTP**, **IP filter**, **CGI alarm service center** and **SNMP**

8.8 Privacy Manager

Add user account, manage the users' permission. As shown in Figure 8-9.

Figure 8-9 Privacy manager interface

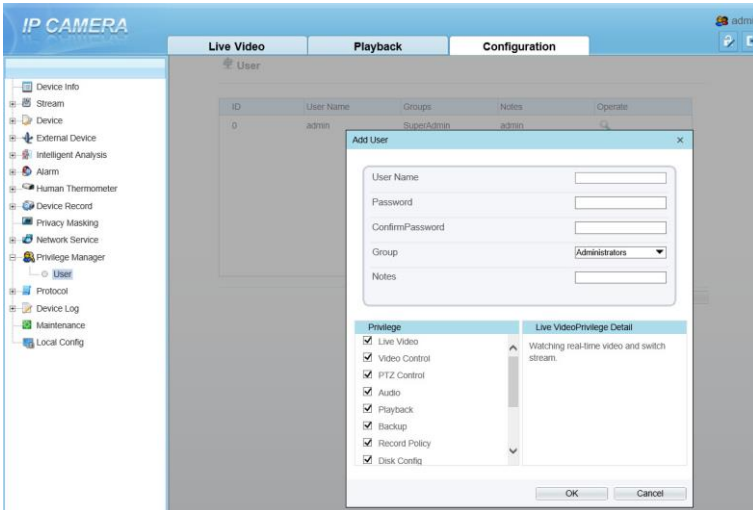

8.9 Protocol

Choose **configuration > protocol**. You can set **protocol information, security, CMS configuration and multicast parameter**.

Figure 8-10 Protocol interface

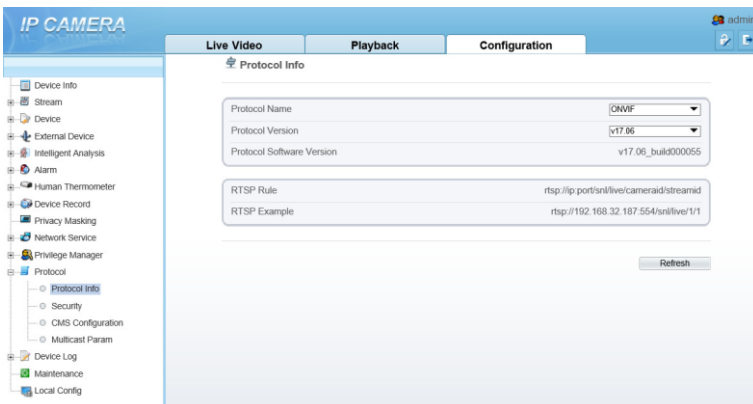

8.10 Device Log

Choose **configuration > device log**. You can view **operation log and alarm log**, or collect all log information, as shown in Figure 8-11.

Figure 8-11 Device log interface

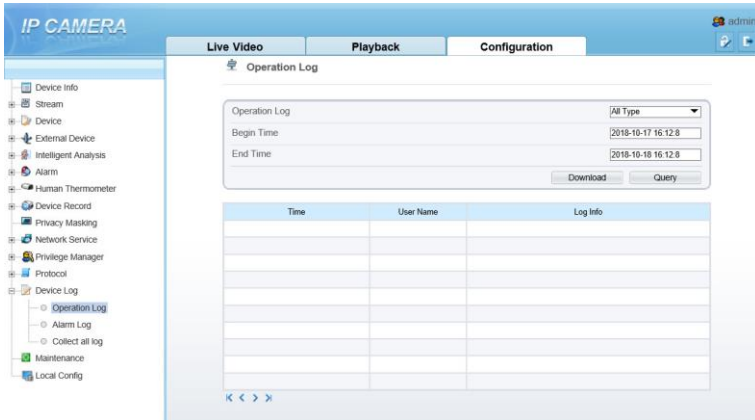

8.11 Maintenance

Choose **configuration > maintenance**. You can **restart, update, reserve IP setting and restore to factory default**, as shown in Figure 8-12.

Figure 8-12 Maintenance interface

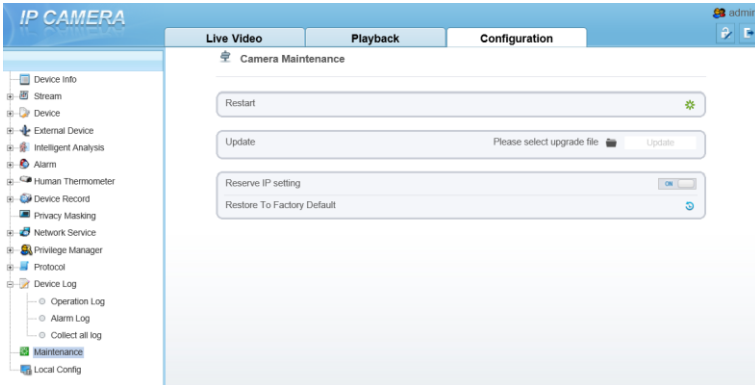

8.12 Local Config

Choose **configuration > local config**. You can choose the snapshot picture format, change the save path of snapshot and local record, as shown in Figure 8-13.

Figure 8-13 Local config interface

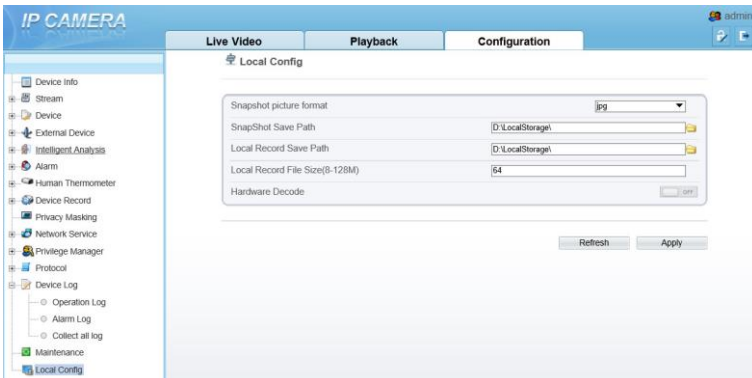

9 Technical Specifications

Table 9-1 lists the specifications of the thermal imaging integrated camera.

Table 9-1 Technical specifications

Type	Parameter	Description
Detector performance	Detector type	Uncooled infrared focal plane sensor
	Sensing mode	Micro bolometer
	Material type	Vanadium oxide
	Pixel	400x300
	Pixel spacing	17 um
	Response waveband	8-14 um
	Thermal sensitivity NETD	50Mk/F1.0
	Frame frequency	50/60 Hz
	Field angle	46° X 35
	Prime lens	8mm
	Focusing mode	manual
F value	1.0	
Visible parameter	Polarity LUT	Black hot / white hot / rainbow / iron bow (up to 17define optional)
	Scene mode	Indoor/outdoor/heaven and earth/linear/common/Costco mode
	Effective pixels	200W 1920(H) X 1080(V)
	WD range	> 120dB
	SNR	> 60dB
	Iris	Auto/manual
	Minimum illumination	Color: 0.1Lux,(F1.2,AGC ON); Black and white: : 0.01Lux

Type	Parameter	Description
		(F1.2,AGC OFF)
	Day/night	With a mobile filter, automatic switch day and night mode
	DNR	3D/2D
	Electric focus lens	2.8MM-12MM
	Image settings	Sharpness/brightness/saturation/gain/adjustable shutter
	Contrast	Support
	Mirror	Support
	OSD display	Support
Video features	Output resolution	D1/CIF
	Frame rate	25/30fps
	Video encode format	H.265/H.264/MPGE
	Video resolution and frame rate	Stream 1:D1 25/30fps; stream 2: CIF 25/30fps
	Multiple code streams	Support
	Bit rate control	CBR/VBR
Audio features	Audio encode format	G.711:8kbps; RAW_PCM:16kbps
	Alarm Temperature Detection	Over-temperature warning, over-temperature alarm.
	measuring-temperature accuracy	Less than 0.3°C after correction (emission, distance, ambient temperature, etc.)
	Multiple temperature area	Support
	Temperature response time	Less than 30 millisecond
	Effective range of working temperature	0°C ~ +60°C
Network	Network protocol	IPv4/IPv6, RTSP/RTP/RTCP, TCP/UDP, HTTP, DHCP, DNS,

Type	Parameter	Description
features		FTP, DDNS, PPPOE, SMTP, and SIP
	WEB management	Embedded WEB service, remote browsing and configuration over IE browser
	Remote upgrade and maintenance	Support
	Integration	Supporting the international standard Onvif ,GB/T28181 and the third-party protocol
	Maximum user access amount	Simultaneous access of 10 users to the maximum
Interface features	Network interface	RJ-45 and 10/100Base-T
	Audio interface	1-channel audio input and 1-channel audio output, supporting bidirectional voice talkback
	Alarm interface	2-channel alarm input and 2-channel alarm output
	Pan & tilt control interface	RS485
	SD card connector	Micro SD card/HCS D card, 128 GB to the maximum
System function features	Intelligent alarm	Motion detection alarm, I/O alarm, and disk alarm
	Intelligent analysis	Area invaded/single virtual fence/double virtual fences/object left/object removed
	Time-phased configuration	Support
	Storage	Local storage, NAS storage, and SD card storage
	Support SDK development	Linux C /windows C&C++ SDK
	Character display	Time, date, channel No., channel name and user-defined characters
Physical features	Power supply	DC 12 V/POE
	Power consumption	10 W
	Operating temperature	-20°C~+60°C(out temperature range needs to add heater or fan)

Type	Parameter	Description
	Operating humidity	RH90% MAX (no condensation)
	Protection class	IP66
	Installation mode	Wall and ceiling
	Dimensions	182*136*220mm
	Sunshade cap	Cartoon type
	Weight	About 1000g

A Troubleshooting

Common Trouble	Possible Cause	Solution
Unable to access the web	Network is not connected.	Connect the network cable of the camera to the PC to check whether the network cable is in good contact. Run the ping command to check the network connection and whether the device works normally.
	IP address is occupied.	Directly connect the camera to the PC, and reset the IP address of the camera.
	The IP addresses of the PC and the device are in different networks.	Check the IP address, subnet mask and gateway setting of the camera.
The measured temperature is not accurate.	The device is just powered on, and the temperature of the cavity is unstable.	The temperature of the cavity is stable within 15 to 30 minutes after the device is powered on.
	The target configuration is incorrect.	Check whether the emission rate and distance of the target are configured correctly.
An error occurs in accessing the web of the device after the upgrade.	The data in the cache of browser is not updated in time.	Delete the cache of the Internet Explorer. The steps are as follows (taking IE9 as an example): Open the Internet Explorer. Select Tools > Internet Options . On the General tab, select Delete under Browsing history . The Delete Browsing History dialog box appears. Select all check boxes. Click Delete . Relogin the web page of the camera.

Common Trouble	Possible Cause	Solution
Upgrade failed.	No network cable is connected. The network setting is incorrect.	Ensure the upgrade network is connected. Check whether the network setting is correct.
	The upgrade package is incorrect.	Perform the correct upgrade package again.

B Common Emission Rate

Emission Rate

The emission rate is the capability of an object to emit or absorb energy. An ideal transmitter provides an emission rate of emitting 100% of intake energy. An object with an emission rate of 0.8 can absorb 80% of intake energy, and reflect the remaining 20%. The emission rate is the ratio of the energy emitted by an object at a specific temperature to that emitted by an ideal radiator at the same temperature. The range of emission rate value is 0.0 to 1.0 generally.

Materials	Temperature (°C/°F)	Emissivity
Gold (High-purity)	227/440	0.02
Aluminum foil	27/81	0.04
Aluminum sheet	27/81	0.18
Aluminum used for families (flat)	23/73	0.01
Aluminum plate (98.3% purity)	227/440	0.04
	577/107	0.06
Aluminum plate (rough)	26/78	0.06
Aluminum (oxidized @ 599°C)	199/390	0.11
	599/1110	0.19
Polished aluminum	38/100	0.22
Tin (light tinned Iron sheet)	25/77	0.04
Nickel wire	187/368	0.1

Lead (99.9% purity, No oxidized)	127/260	0.06
Copper	199/90	0.18
Cobalt	599/111	0.19
Steel	199/390	0.52
	599/1110	0.57
Tinned iron sheet (Light)	28/82	0.23
Brass(High-polish)	247/476	0.03
Brass (Tough rolled, polished metal wire)	21/70	0.04
Tinned Iron (Light)	-	0.13
Iron plate (Rust eaten)	20/68	0.69
Rolled steel sheet	21/71	0.66
Ferric oxide	100/212	0.74
Wrought-iron	21/70	0.94
Fused iron	1299-1399/3270-2550	0.29
Copper (Polished)	21-117/70-242	0.02
Copper(Polished, not reflected)	22/72	0.07
Copper (Heavy oxide Board)	25/77	0.78
Enamel (Fuse on iron)	19/66	0.9
Formica Plate	27/81	0.94
Frozen soil	-	0.93

Brick (Red, rough)	21/70	0.93
Brick (Unglazed, rough)	1000/1832	0.8
Carbon (T - carbon 0.9% ash)	127/260	0.81
Concrete	-	0.94
Glass (Glossy)	22/72	0.94
Granite (Surfaced)	21/70	0.85
Ice	0/32	0.97
Marble (I Polished, grey)	22/72	0.93
Asbestos board	23/74	0.96
Asbestos paper	38/100	0.93
	371/700	0.95
Asphalt (Paving the road)	4/39	0.97
Paper (Black tar)	-	0.93
Paper (White)	-	0.95
Plastic (White)	-	0.91